

**Materials I Need:**

**Legend:**

-  = Option 1, Appropriate for 1<sup>st</sup> – 2<sup>nd</sup> Grade  
 = Option 2, Appropriate for 3<sup>rd</sup> – 6<sup>th</sup> Grade







**Focus Verse:**



“In everything he did he had great success, because the LORD was with him.” 1 Samuel 18:14



**Memory Verse:**

“Man looks at the outward appearance, but the LORD looks at the heart.” 1 Samuel 16:7b

## Hook:

- Paint Stones (Activity).** ,  Bring in stones, enough for each student, and have the students paint them with scented markers. As the students paint the stones, the teacher can show pictures and talk about different types of weapons. Ask the students what they would choose if they were facing a large army or going up against a huge enemy. Set the stones aside to dry during class as they will be used to complete a craft during the LOOK time. This morning they will hear about a young boy who fought against a giant and killed him, using only one stone.
- What Weapon Would You Use? (Object Lesson/Discussion).** ,  Bring in a variety of pictures of weapons (i.e., sword, spear, bow and arrow, knife, gun, cannon, grenade, slingshot). Talk about the types of weapons that have been used during time of war. (Contact Children’s Ministry for plastic swords and armor.) You may also want to bring in pictures of the Civil War, cowboys and Indians, a samurai warrior, etc., and talk about military strategy (National Geographic magazines are a good source). Tell the students that usually the bigger army with the more modern weapons wins. Talk about how, in today’s Bible Adventure, they will hear about how a young boy used nothing more than a smooth stone to win a battle.
- Let’s Talk About Success (Discussion).** ,  Bring in pictures of what most people think success is (i.e., athletes, business people, farmers). Ask students what they think success is. Is it getting good grades, winning a race, being the best at something, or getting recognition? Have they ever had a goal and accomplished it? Has there ever been an instance in their lives that they were successful? What did they do, and do they think that they were successful on their own strength and ability? Explain that the Bible’s definition of failure and success is very different than ours. Whatever is not done by faith is sin (Romans 14:23). Whatever is done to please God is success (2 Corinthians 2:9-10). Anything that is done for God’s glory is success. We will see today that, against all odds, a young man was successful because he acted to please God.
- What Brings Success? (Visual/Discussion).**  Color 1SM04.GF1 Pgs. 1-11 before class. Define success to the students as being able to do something we try to do. Hold up one picture at a time, or call on a student to come up to choose one. Tape it to the whiteboard. Ask the class, “Can \_\_\_\_\_ (whatever the picture shows) bring us success? Why or why not? How can this help us to be successful?” Tell the students that today they will hear from God’s Word what the truth is about being successful.

 **Work Gloves (Object Lesson).** ,  Bring in a variety of gloves. Ask the students for what purpose each type of glove is used. Ask them if a glove can do work on its own. No, it needs someone's hand to fill it. Explain that gloves are simply tools to accomplish work. Most gloves need to be "broken in" before they are most effective. Bring in a well-worn baseball glove or work glove. Explain to the students that gloves are very useful to the one who broke them in. David was going to be king of Israel. He was to be God's chosen instrument to lead Israel. On the outside, it looked as if he, David, was doing the work, but he was merely a glove for God to do His work through. Today the students will see how David was moved by God to accomplish His will.

 **Do Heroes Wash Dishes? (Discussion).** ,  What makes a hero? Ask students about famous athletes who are considered heroes. Do they have to train hard to win in their sport? Of course they do. They have to do the little things that make them better. A Biblical hero is one who is faithful to God in the small duties as well as the large. In the Bible Adventure today, the students will see that David started out as a humble servant who was faithful to God and how his faithfulness paid off.

---



### Book:

#### Presentation Ideas –

 **Samuel Anoints David (Illustration/Coloring Page).** ,  1 Samuel 16:12-13, **1SM04.GF2.**

 **David Plays the Harp for Saul (Illustration/Coloring Page).** ,  1 Samuel 16:21-23, **1SM04.GF3.**

 **Goliath Stands Before the Frightened Israelite Army (Illustration/Coloring Page).** ,  1 Samuel 17:1-11, **1SM04.GF4.**

 **David in Saul's Armor (Illustration/Coloring Page).** ,  1 Samuel 17:38-39, **1SM04.GF5.**

 **David Swings His Sling in the Air (Illustration/Coloring Page).** ,  1 Samuel 17:49, **SM04.GF6.**

 **David Kills Goliath (Illustration/Coloring Page).** ,  1 Samuel 17:49-51, **1SM04.GF7.**

 **Saul Throws a Spear at David but Misses (Illustration/Coloring Page).** ,  1 Samuel 18:10-11, **1SM04.GF8.**

 **David and Jonathan Embrace and Weep (Illustration/Coloring Page).** ,  1 Samuel 20:41-42, **1SM04.GF9.**

#### **Bible Adventure for K – 2<sup>nd</sup> Grades –**

Samuel was extremely sad. Saul had been a miserable failure as king of God's chosen people. His stubborn pride had kept him from whole-hearted obedience to the Lord, and God finally rejected him. As Samuel grieved over Saul's downfall, God told him to get up and be on his way because He had chosen a new king for Israel, one that would desire to obey God with all his heart.

The Lord instructed Samuel to take his horn filled with oil and go to the small town of Bethlehem in order to anoint the next king of Israel. Samuel was afraid that if Saul found out what he was doing, he would kill him so God told him to take a heifer for the purpose of making a sacrifice. Samuel obeyed God's command and went to Bethlehem.

When he arrived, he called the family of Jesse to the sacrifice. Jesse came with his seven oldest sons. When Samuel saw the oldest son, he thought to himself that, surely, this must be the chosen king because he was tall and handsome, just like Saul. The Lord knew what Samuel was thinking and corrected him by saying, "Do not consider his appearance or his height, for I have rejected him. The LORD does not look at the things man looks at. Man looks at the outward appearance, but the LORD looks

at the heart" (16:7). The Israelites had already made the terrible mistake of choosing a king based on how he looked. But God would choose this time and His choice would be based on the heart of the person and his love for Him.

With this truth in mind, Samuel looked at the next son in line, and the next, but God's chosen king wasn't there. Samuel asked Jesse if he had any more sons. Jesse replied that the youngest was out in the field caring for his sheep. Samuel asked to see him, and when David arrived, God said to Samuel, "Rise and anoint him; he is the one." Samuel then put oil on David, which showed that God had indeed chosen David as the next king. The Holy Spirit came upon David to give him the power and strength for the job ahead.

As soon as the Spirit of God came upon David, it left Saul. God sent an evil spirit to torment Saul. As a result, Saul suffered from great depression, anger and confusion. His servants suggested that perhaps some beautiful music might ease his suffering. God planned that David would be the one to be called in to play his harp for Saul.

God also raised David up as a military leader in Israel. The Philistines had once again gathered their army to fight the Israelites. They had a giant named Goliath among their ranks. Goliath was nearly ten feet tall and his armor alone weighed around 125 pounds! Saul and the rest of the Israelite army were so scared because they feared that no one in their camp could beat this Philistine giant. While Goliath made fun of the Israelites and their Lord, David happened upon the scene as he brought food to three of his older brothers who were in the army. When David heard the terrible things that Goliath was saying, he could hardly control himself. He wondered who this filthy-mouthed Philistine was who was saying such awful things about God.

David convinced Saul that he would be the one to take on this giant. Saul was reluctant because David was so young but no one else would do it! Saul tried to give David his armor to wear but it was way too big. David instead chose to pick five smooth stones from a nearby brook. When David approached Goliath, Goliath was insulted that Israel would send out a mere boy to fight him. But David ignored him and shouted, "All those gathered here will know that it is not by sword or spear that the LORD saves; for the battle is the LORD's, and He will give all of you into our hands" (17:47). With that, he pulled out a stone and placed it in his sling. He swung it around and let go and hit Goliath right in the middle of the forehead! BOOM! Goliath was down. The big giant had died and the Lord gave David and Israel a great victory over the Philistines.

Word spread throughout Israel of the mighty deed David had done. Because David was such a hero, Saul became very angry and jealous and wanted to kill him. He sent David out into the middle of the very worst wars, hoping that he would be killed in battle. But the more David went out leading the troops, the more he was victorious. There was nothing Saul could do to harm David because God was with David. And since God was with him, he was successful in all he did.

As Saul's anger toward David grew, David had to flee the kingdom to avoid being killed. David spent years running from Saul. But since God was on David's side, all of Saul's attempts to kill him were useless. David's faith in God grew and he learned to trust Him during times of great trouble. God used all of David's difficulties to prepare him for being king.

Clearly, we learn from the story of David that God is not concerned with what we look like on the outside. God chose David not because of his looks but because David genuinely loved Him. Regardless of how we look, we can grow in our love for God in our hearts. This is what truly pleases Him!

We also learn from the story that success comes from the Lord. No matter how hard he tried, Saul could not take David's life. But David had repeated victories over his enemies because God was with him. Life lived apart from God is ultimately doomed to failure but a life lived with and for God will be a success.

### ***Bible Adventure for 3<sup>d</sup> – 6<sup>th</sup> Grades –***

Few things in Israel had caused such excitement as the choosing of Saul as king. Tall and extremely handsome, Saul was a man the people wanted as their leader. Unfortunately, they weren't concerned about what the inner Saul was like, but God saw and was displeased with what He found: that Saul's heart was not concerned with putting Him first.

Saul was always wanting to make himself look good, and he relied on his own strength to get things done, instead of trusting God's plan for his life. For this reason, and because of Saul's disobedience to His commands, God rejected him as king and began to look for a man after His own heart.

The failure of Saul and his rejection by God had been difficult for Samuel. He was saddened by the way things had turned out, but God had other plans for the nation of Israel. He came to Samuel and commanded him to take his horn filled with oil and go to the small town of Bethlehem. There he was to anoint one of the sons of a man named Jesse as the next king of Israel.

Samuel was frightened because God had asked him to do this. He told the Lord that if Saul found out what he was doing, he would kill Samuel. God gave Samuel a wise idea: take a heifer to offer as a sacrifice to the Lord, and invite Jesse and his family to the sacrifice. Then God would show Samuel which of the sons was His chosen king.

When Samuel arrived in Bethlehem, he called Jesse and his family to the sacrifice. Seven of Jesse's sons came with him, and when Samuel saw the oldest one, Eliab, he thought he was looking at God's choice for the next king. Eliab was tall and handsome, like Saul. But God told Samuel, "Do not consider his appearance or his height, for I have rejected him. The LORD does not look at the things man looks at. Man looks at the outward appearance, but the LORD looks at the heart" (16:7). The whole nation had chosen Saul based on his appearance, but God's choice would be based upon what the king's heart and character were like, and how much he loved God.

Thinking about what God had told him, Samuel looked at all seven of Jesse's sons who were present. God had not chosen any of them, so Samuel asked Jesse if all his sons were there. Jesse answered that his youngest was out taking care of the flocks. Samuel sent for the son, David, and when he arrived, God told Samuel, "Rise and anoint him; he is the one." Samuel did this as a sign that God's authority would now rest upon David as king of Israel. Immediately the Spirit of God came upon David, giving him the power he would need to lead the nation. There were plans that God would put into action, first, however, so that David would rise into his leadership position.

When the Spirit of the Lord came upon David, it also left King Saul. God then allowed an evil spirit to come and trouble him. Saul, who had already shown his lack of wisdom, now struggled with depression and anger and became even more unwise in his thoughts and behavior. When his servants saw what was happening, they suggested that Saul find someone skilled at playing the harp to come and try to soothe him with music. This was all in God's plan, as it was soon discovered that David was one of the most skilled musicians in the land. David was brought to the palace to play for Saul and became one of the king's inner circle of servants.

During this time, the war with the Philistines continued, and they had once more gathered their army to fight the Israelites. The Philistine army stood on one mountain and the Israelite army on the other, with a valley between them. One of the Philistines stood out from the rest of the army, and even at a distance, he had the attention of every Israelite soldier. The Philistine's name was Goliath, and he was huge. Standing between nine and ten feet tall and dressed for battle (his armor alone weighed 125 pounds), Goliath was enough to put fear into the heart of any man. He yelled at the Israelites, daring them to send someone out to fight with him. He said that if the Israelite soldier won, the Philistines would be their servants. If Goliath won, the Israelites would serve the Philistines. Sounds simple, right? Sure, if bringing down a man the size of a mountain is simple! One look at Goliath and the Israelites, right down to King Saul, were quaking in their boots!

For forty days, morning and evening, this went on. Goliath yelled his challenge, and mocked the Israelites for failing to respond. Then one day David, who had come to the camp to bring food for his older brothers, heard Goliath's challenge. David could hardly believe his ears--did this Philistine have no fear at all of God, whose army he mocked and defied? David went to Saul and convinced him that he was willing to fight the giant. At first, Saul said no, but then he realized that no one else was willing to fight Goliath, and he was not going to disappear! Saul had David try on his armor, but David decided it was too big and awkward to wear, so instead he went to a nearby brook and picked up five smooth stones. He put them in a pouch, took his staff and his sling, and went out to meet the enemy.

When Goliath saw who it was coming out to fight him, he was insulted. The Israelites were sending a youth, and an unarmed youth at that, to fight with him? Goliath cursed David and told him he would feed

him to the birds. But David was not afraid, and the reason is that his faith was not in his own strength or ability to win this battle. Listen to his words to his fearsome opponent: "You come against me with sword and spear and javelin, but I come against you in the name of the LORD Almighty, the God of the armies of Israel, whom you have defied. This day the Lord will hand you over to me. . .and the whole world will know that there is a God in Israel. All those gathered here will know that it is not by sword or spear that the Lord saves; for the battle is the LORD's, and He will give all of you into our hands" (17:45-47). Can't you almost hear David's words vibrate through that valley? Those who would dare to stand against the Lord and against His people would see that God is the One who holds all the power. At the end of the battle, every single soldier, Philistine and Israelite, would see God's glory.

Running toward the Philistine army and Goliath, David pulled out a stone, placed it in his sling, and threw it right into Goliath's forehead. The huge man fell to his death and God gave David and Israel a great victory that day. Word spread throughout Israel that David was the hero of the battle. Saul heard the people praising him and became very jealous of David. From that day forward, Saul's heart turned against David in anger and envy, to the point where he desired to take David's life. In fact, there were 20 different occasions where Saul desired to put David to death. Saul would send David out into the fiercest battles, hoping that he would fall, but David always came back victorious. Saul had spies watching David for an opportunity to attack him. He even tried to kill David with a spear while David played the harp for him. Each time, David escaped harm because God was with him, protecting him. God sent people to help him, like David's wife, Michal, who was Saul's daughter, and Saul's son, Jonathan, who loved David like a brother. As Saul's anger toward David grew, David began to think he should leave the kingdom in order to live. Jonathan decided to help by trying to see what his father really planned for David. When he questioned Saul, Jonathan realized that Saul's hatred and desire to see David dead were as strong as ever. He signaled David that it was not safe for his friend to be around the king any longer.

This was the beginning of David's years as a fugitive, running from King Saul. Although Saul was powerful, God was on David's side, and Saul was not able to harm him. God was preparing David for the kingship, and there was nothing Saul could do to fight God's sovereign hand. Already David was growing in his faith in God through the difficult things he was going through. The message we should be getting, through God's choice of David as king, is that it's not what's on the outside that counts. How totally opposite of what we hear in the world today, where looks are so important. We need to remember that God is not impressed by a pretty face or athletic body. What pleases Him is a heart that seeks Him above all else.

#### Aim Questions:

1. **Who did Samuel originally think was God's choice to be the next king of Israel? Why?** *Samuel thought it was Eliab, Jesse's oldest son, because he was tall and handsome like Saul.*
2. **Why did God choose David over his older brothers?** *Because David had a heart for God.*
3. **What were some of the key battles in which David fought that God gave him great victory?** *He killed Goliath and defeated the Philistines many times.*
4. **What did Saul think of David's growing success in Israel?** *Saul became greatly jealous of David and hated him.*
5. **What did Saul then try to do to David?** *He tried to kill him on numerous occasions.*
6. **Why did Saul always fail to hurt David?** *Because the Lord was with David and was protecting him so that he could become the next king of Israel.*
7. **What are some things that you've personally learned from today's lesson?**



#### Look:



**Where Is Your Confidence? (Discussion).**  Ask students what they think they do well.

Explain that when we think we are good at something, it gives us confidence. When we are NOT good at something, we don't have confidence. But is this really how God wants us to view confidence? Our real confidence should not come from our own ability but from God. Reread David's fight with Goliath and see where David put his confidence. How can we put our confidence in God?

**That Hurts My Ears! (Discussion).** 🦋, 🦋 Ask the students the following questions: “How do you respond when someone says bad things about Jesus? Have you ever heard someone take the Lord's name in vain? How do you respond when you hear something like that? What does the Bible say about using God's name wrongly?” Explain to them that Goliath was taunting God's people and cursing David. He was mocking the Israelites and God. When David heard the words spilling out of Goliath's mouth, he could hardly contain himself. David responded by giving all the glory to God for Israel's deliverance. There was no mistake as to who had the power for victory over the enemies. God does not want us to be throwing or shooting stones at those who speak badly about Him, but He does want us to stand up for what is true and right. Encourage the students that the next time they hear harsh words spoken against the Lord, not to just sit there but to say something.

**Sling Shot (Craft).** 🦋, 🦋 Each student will need:  
example sheet from **1SM04.GF10 Pg. 1**  
labels from **1SM04.GF10 Pg. 2**  
3 craft sticks  
18-in. piece of yarn for sling  
3 x 1 ½ piece of felt  
1 sheet of construction paper  
small rock  
glue  
scissors

Have students glue the craft sticks together and paste them down on the construction paper as shown. Glue the yarn down with the top ends on top "V" sections of the craft sticks. Next, have them glue the stone that they painted during the HOOK time in the sling. Leave flat to dry. Finally, add the Bible verse at the bottom of the page and the title label at the top.

**Bragging Puppets (Activity)** 🦋, 🦋 Ask the students what ‘bragging’ means. Brainstorm a list of the things about which people brag. Ask the students if they can think of a character in 1 Samuel that might have been heard bragging. When Saul and Goliath are mentioned, write them on the board and begin to list the things that they might have bragged about. Suggest David as a possible braggart and have the kids argue for or against him. List the types of things he might say to people or brag about. After contrasting these other characters with David, ask two volunteers to come forward and act out a dialogue between a Goliath puppet and a David puppet and then between a Saul puppet and David. Have them brag about things that were already listed. To be creative, you might change the scene and have Goliath show up as a new student in elementary school, or have Saul come to a birthday party. Conclude the activity by asking the students which of these characters actually succeeded in the Bible stories. Ask them to tell you what David's success was specifically. Talk about a successful attitude and a right heart.

**Who Really Has the Power? (Worksheet).** 🦋 Have students use their NIV Bibles and the clue verses provided on **1SM04.GF11** to find the best word to solve the puzzle. Have them look up the verses and try to find the appropriate words that fit. Be careful because some of the verses may have more than one word with the right number of letters. *Answer: 1 Samuel 18:14*

**Maze to Success (Worksheet).** 🦋 Each student can color and follow the maze and be reminded of the success that God gave to David, **1SM04.GF12**.

**Aim Questions (Worksheet).** 🦋 Have students answer the aim questions about today's Bible Adventure, **1SM04.GF13**.

**Passage Review Questions (Worksheet).** 🦋 This booklet contains many questions from the Scripture passage covered in today's lesson. Students may work on them in class and complete them during the week at home, **1SM04.GF14**.

**1 Samuel 16:7b (Memory Verse Song).** 🦋 Words and music for today's memory verse are available upon request from Children's Ministry.



## Took:

- 1 Samuel 15-20 Game (Take-Home Game).** 🦋, 🦋 Copy **1SM04.GF15 Pgs. 1 & 2** for each student to take home. Put the game together in class by taping sheets together in the middle. Encourage students to challenge their families to a game.
- Centerpiece of Success (Craft).** 🦋, 🦋 Fold a 12" x 18" sheet of construction paper for each student (holding the paper horizontally, fold in half, and each side in 3"). Give each student one folded sheet and **1SM04.GF16 Pgs. 1 & 2**. Have them color the picture of David's success with markers and cut out and glue on one of the sides closest to the center. Then have them glue the two 3" folds together forming a triangle. Have them take the calendar from **1SM04.GF16 Pg. 1** to complete at home together with their families.
- Successful Sailing (Discussion/Craft/Activity)** 🦋 Explain to the students that a sail on a boat is only successful when it coordinates with the wind. Without careful coordination, only frustration occurs. Discuss what might happen to a person who attempts to control a sailboat for the first time without lessons. In the same way, we must coordinate with the Lord's will in order to be successful. God will frustrate, or thwart, the proud who seek their own will as He did with Saul when Saul was trying to kill David. Challenge the students to make a successful sailboat. Provide the students with the materials for making a sailboat craft: boat shell from the bottom half of a paper cup, straws, tape, toothpicks, and clay or sticky-tack. Also supply students with **1SM04.GF17** so that they might choose a sail shape from among the options to cut out and apply to their boat. Have a long gutter, or the like, sealed and filled with water and a fan. You may choose to define "success" for the sailboat before the activity: for example, racing the sailboats or simply accomplishing the journey from one end of the gutter to the other. To conclude, discuss what real success was in this activity. Was it a fast or good-looking sailboat? Or was it the attitude of joy and humility? What kind of success would God like to give each person in this kind of activity?
- Everyday Successes (Activity/Prayer).** 🦋, 🦋 Have students share if there have been times this last week where they have obeyed on a test or assignment or in a game. Encourage the students to take time to thank God for the little successes in their days. Explain that giving God thanks for His help gives Him the glory. It is important to acknowledge that God gives us the ability to do well and have success.
- Thanking God for His Faithfulness to Me Placemat (Craft).** 🦋, 🦋 Review the concept that all the success we have in our lives comes directly from the grace of God. Explain to the students that without God, we will not be successful at anything. Talk about the successes that God gave David after he was selected to lead God's people. To whom did David give the credit? David gave God all the glory for everything he did. We need to remember who allows us to be successful in all that we do each day. Whether we have been successful in keeping our room neat, being kind to our siblings, doing well at school, or winning in a sport, our success comes from God. As we acknowledge His power in our lives, we can thank Him. Enlarge **1SM04.GF18 Pg. 1** to 11" x 17" size. Give each student enough placemats (**1SM04.GF18 Pg. 1**) and sets of stones (**1SM04.GF18 Pg. 2**) to paste on the placemats for family members at mealtime. Each family member is to take a turn to tell of his or her successes throughout the day. Each time they thank God for His faithfulness in their lives, they may paste one stone on the placemat. Have the students color or decorate the placemats for each of their family members. Make sure the parents understand how they are to be used this week.

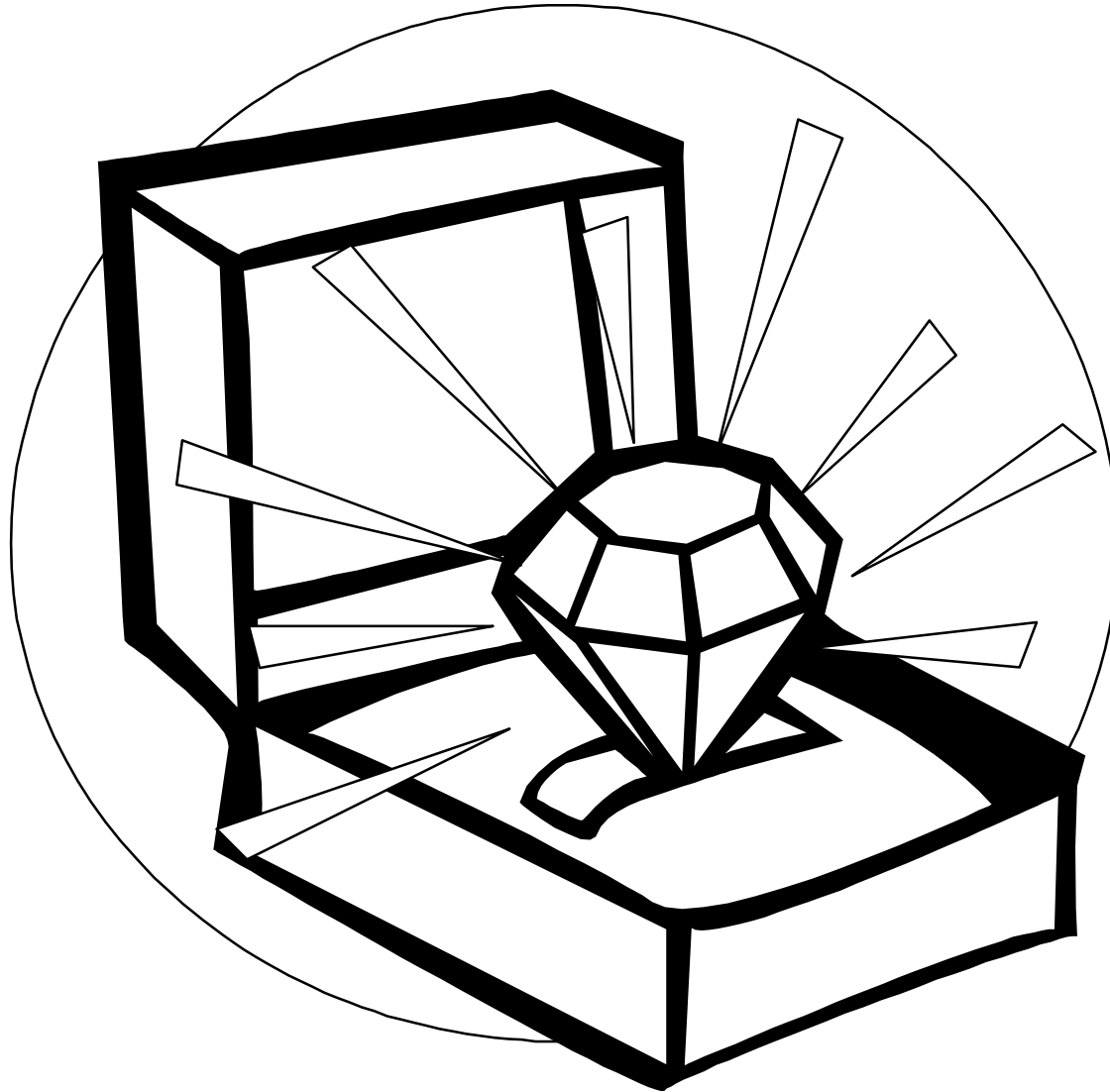

# Jewels

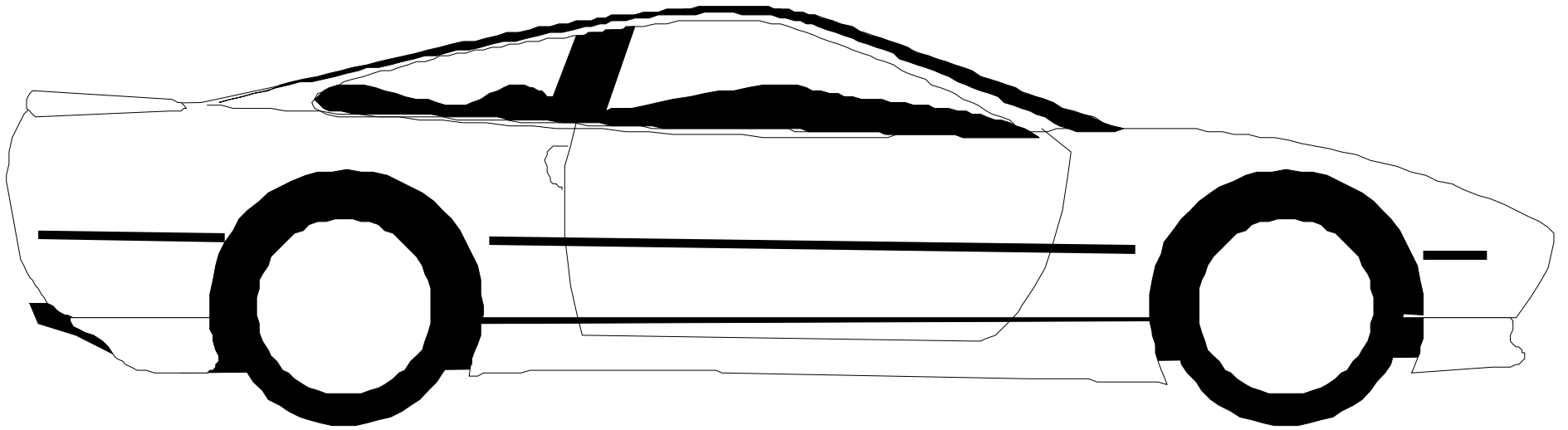

# Fancy Car



# Big House

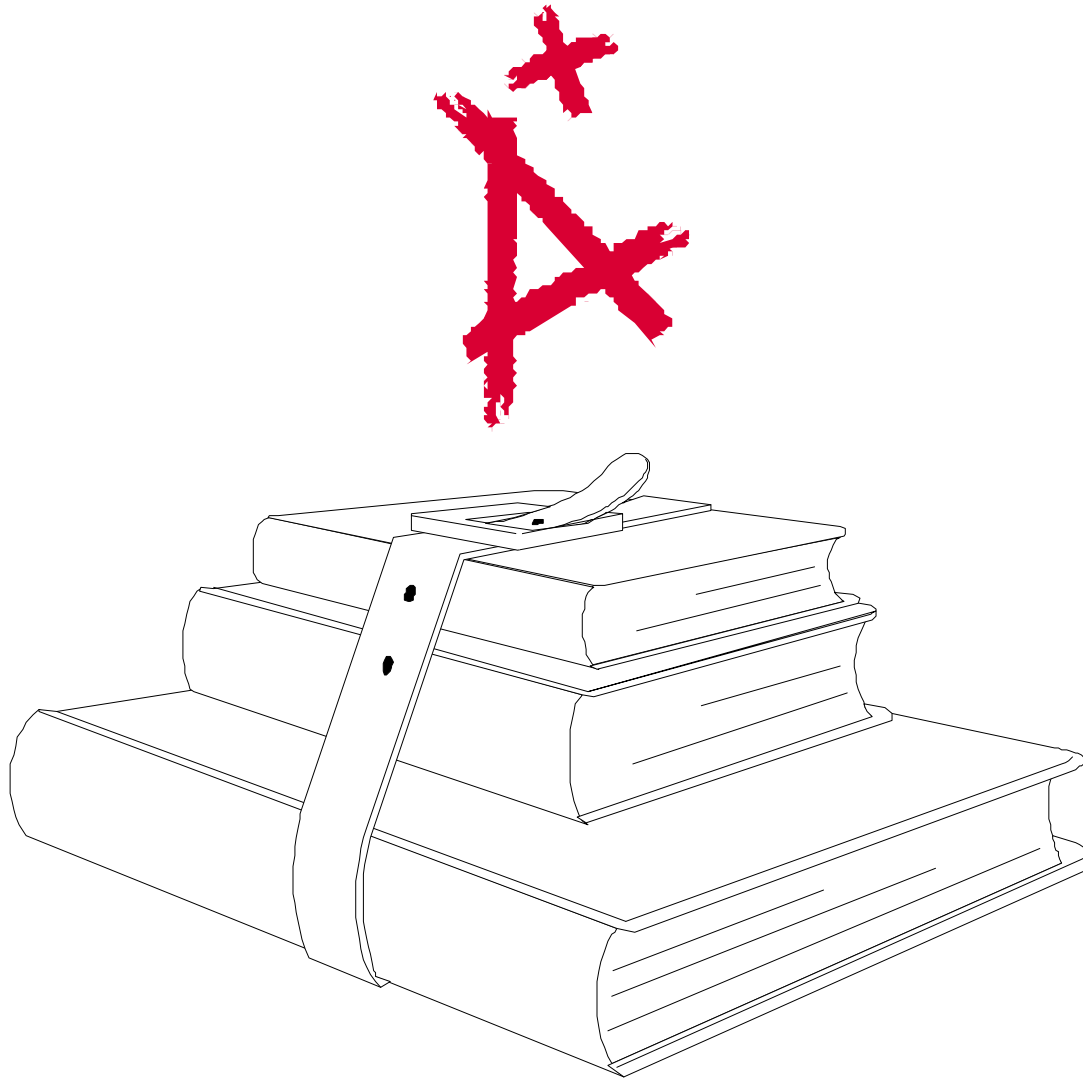

# Being Smart

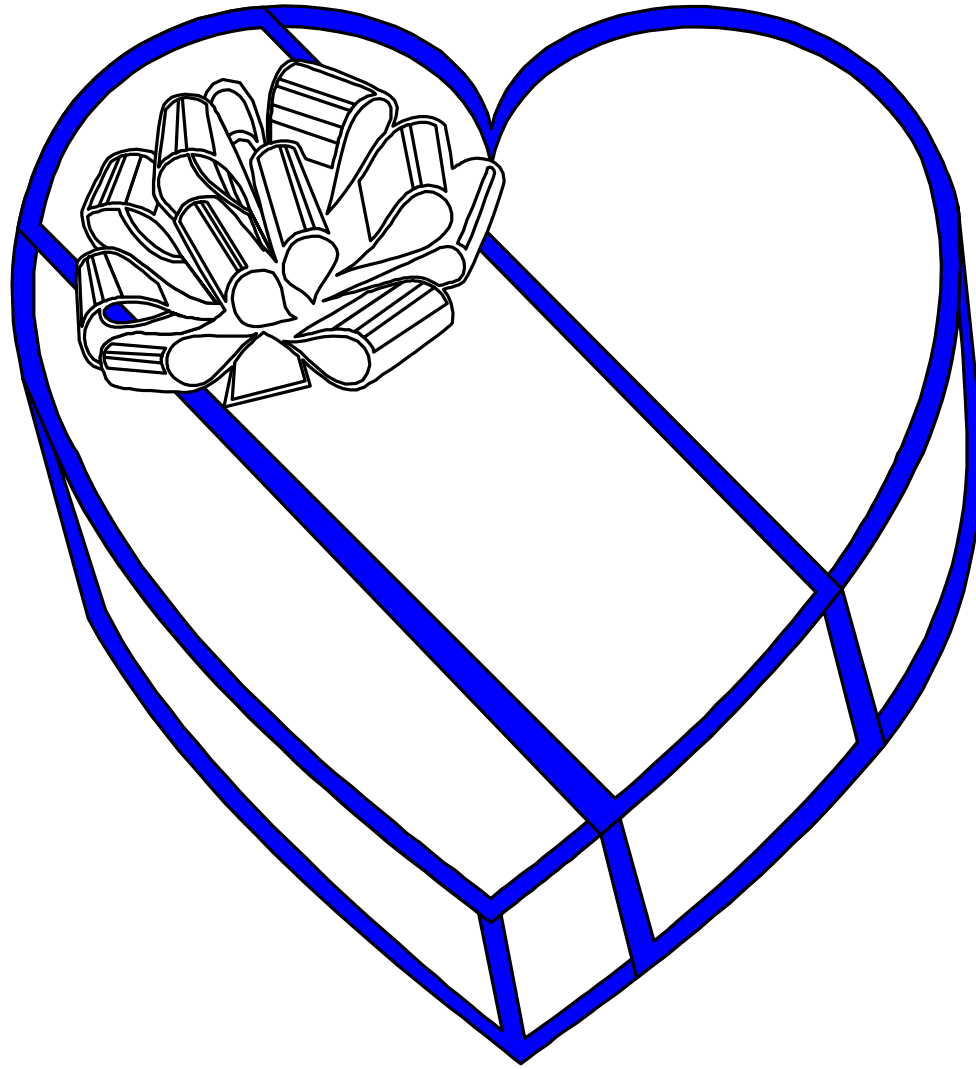

**Kindness & Love**

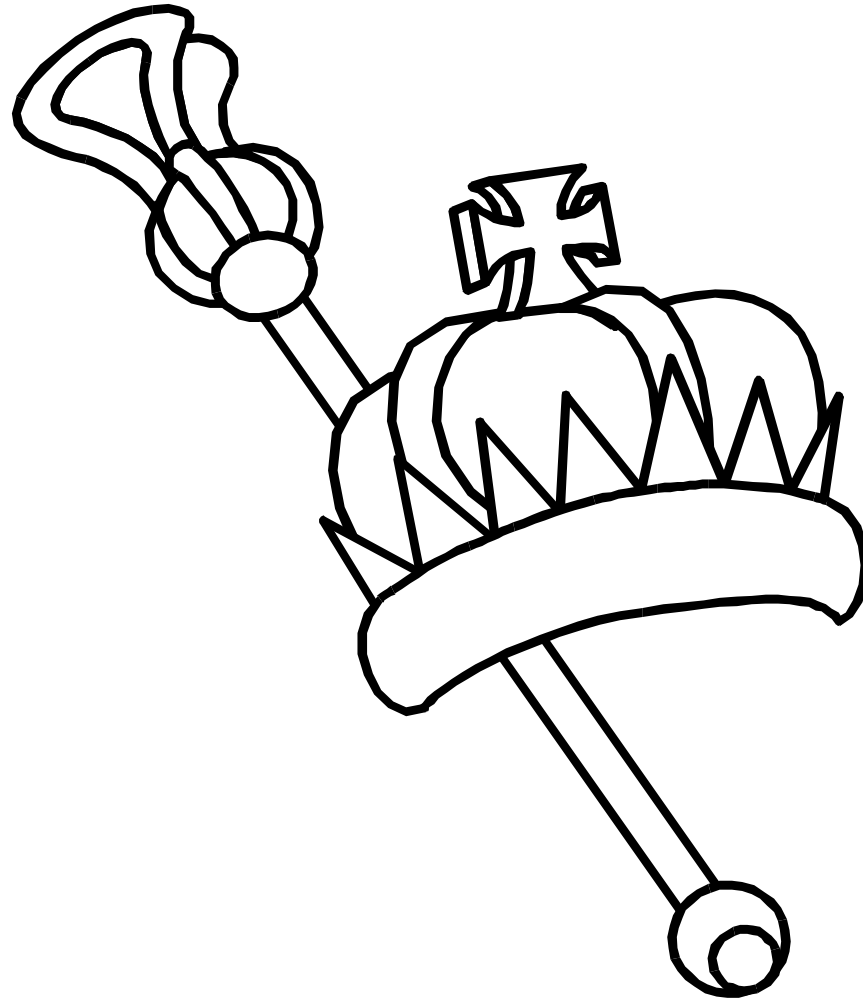

# Royalty



**Lots of Money**

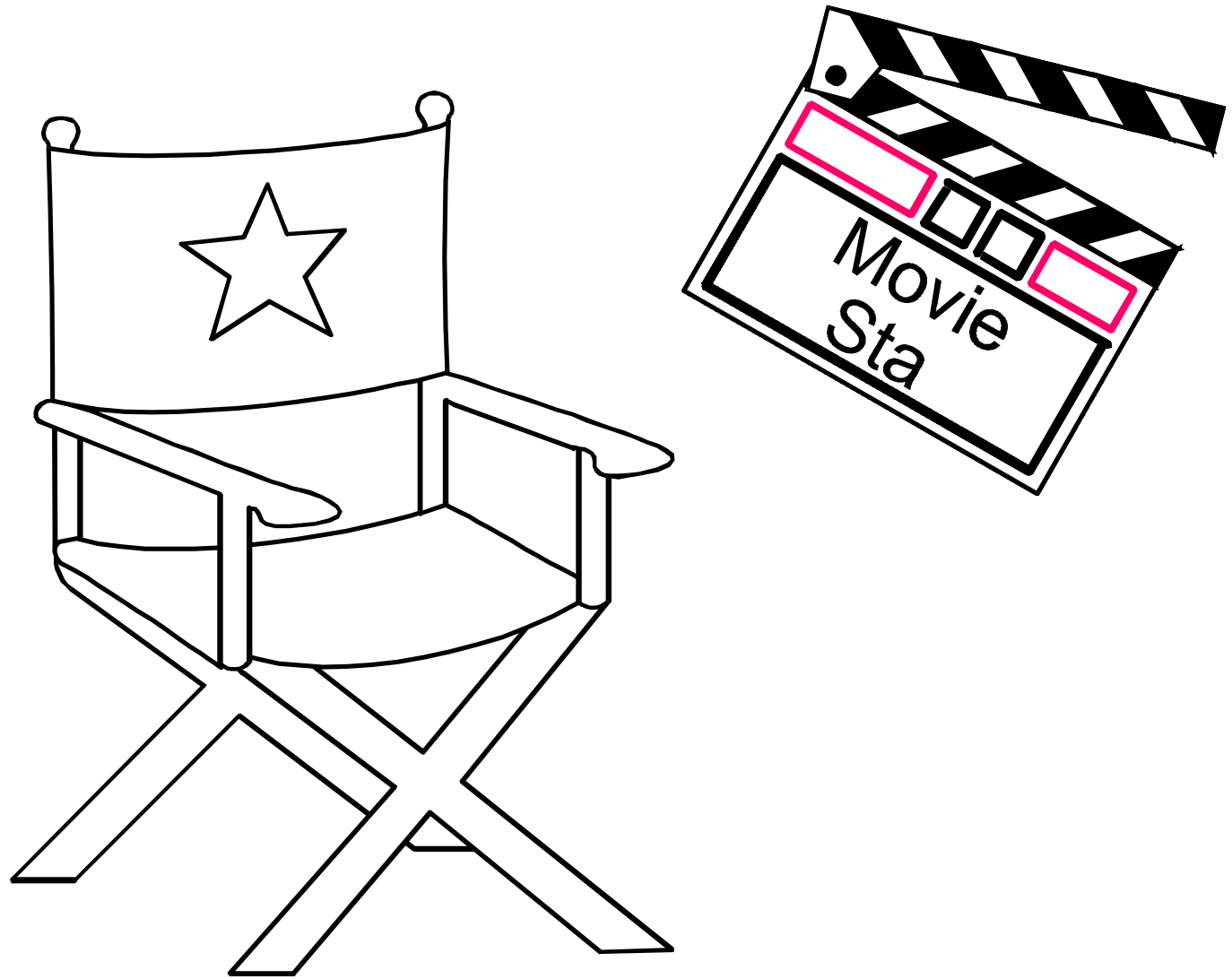

# Being Famous



# Being Brave



# Marriage

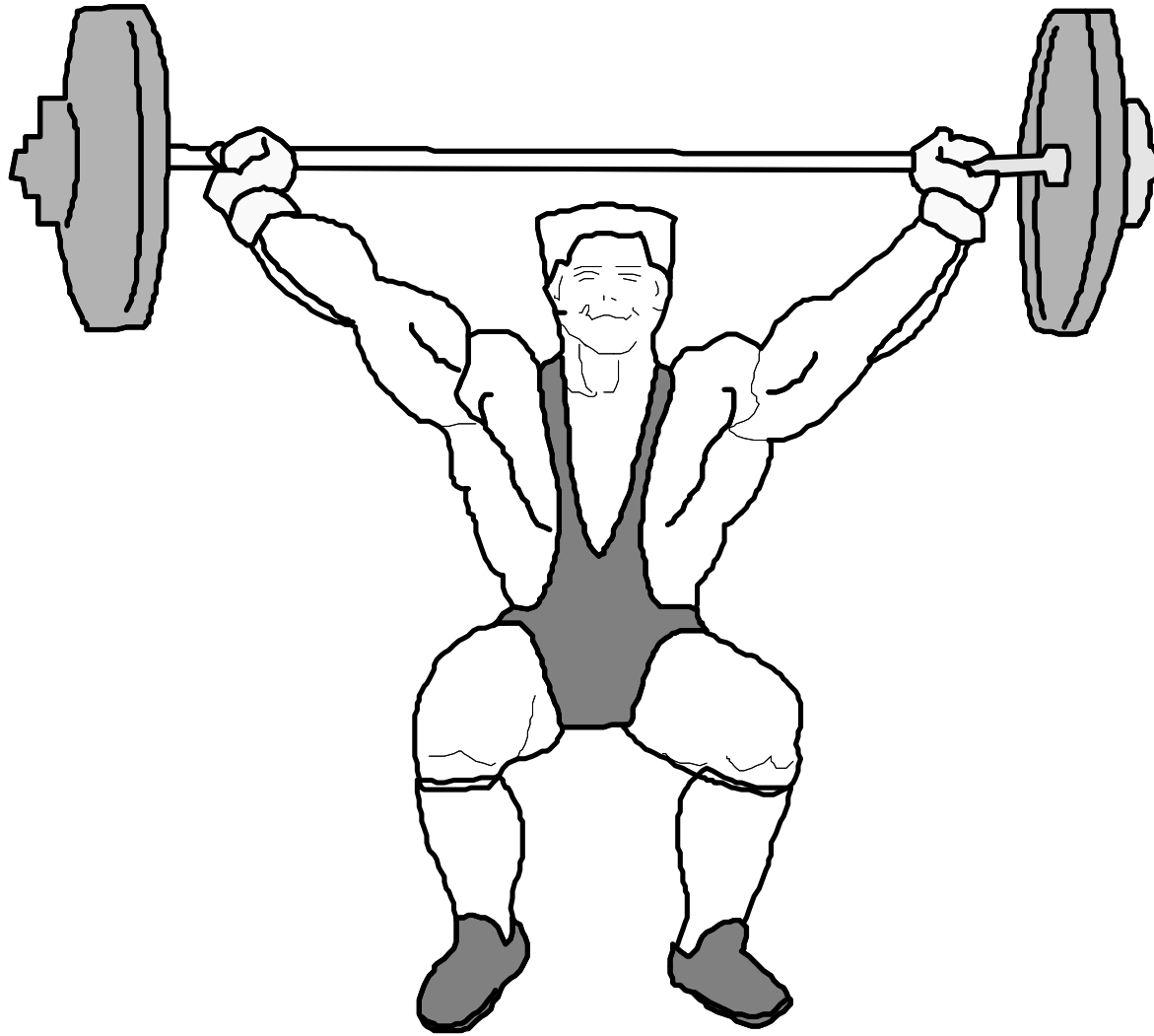

# Strength

# Samuel Anoints David



# David Plays the Harp for Saul



# Goliath Stands Before the Frightened Israelite Army

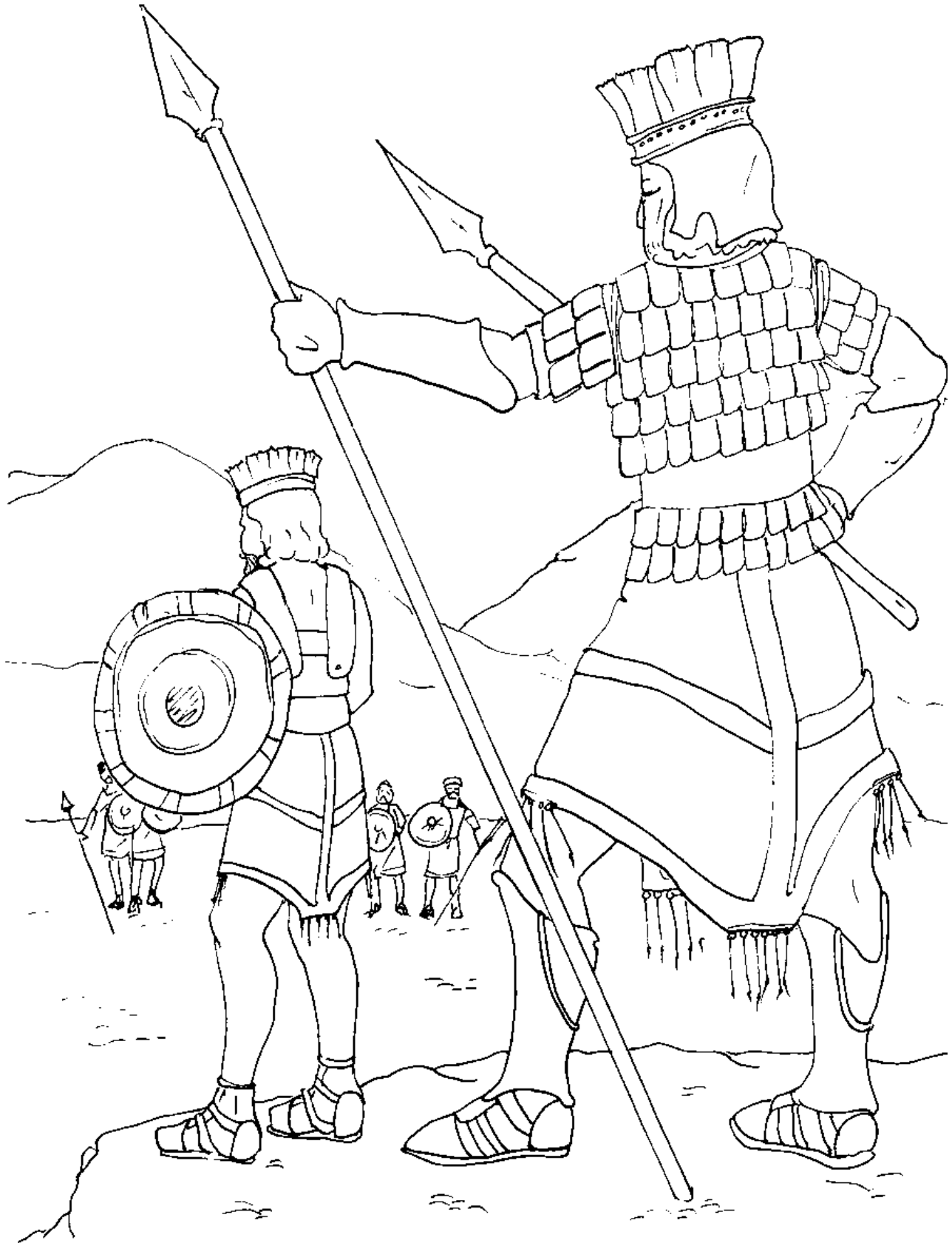

# David in Saul's Armor

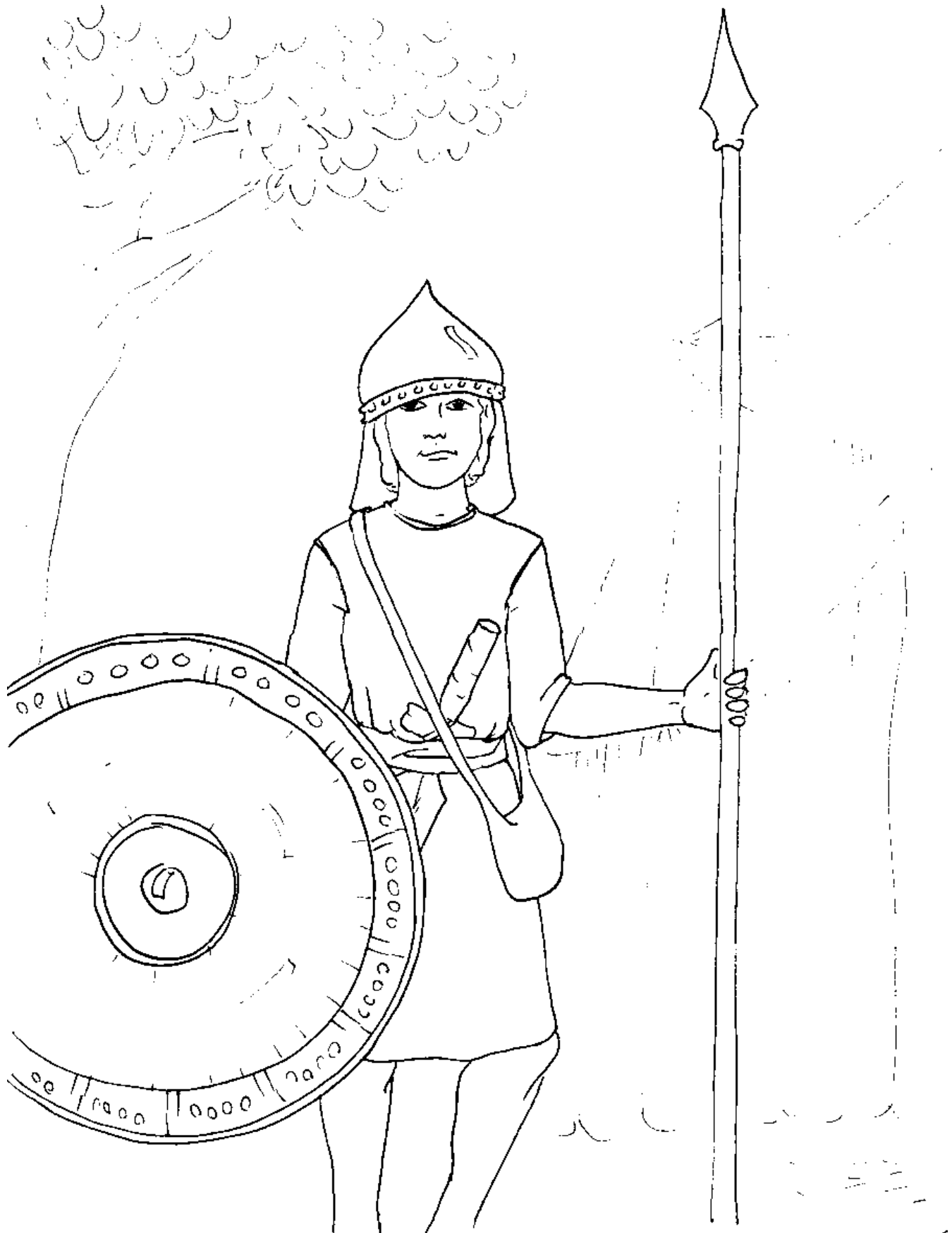

# David Swings His Sling in the Air

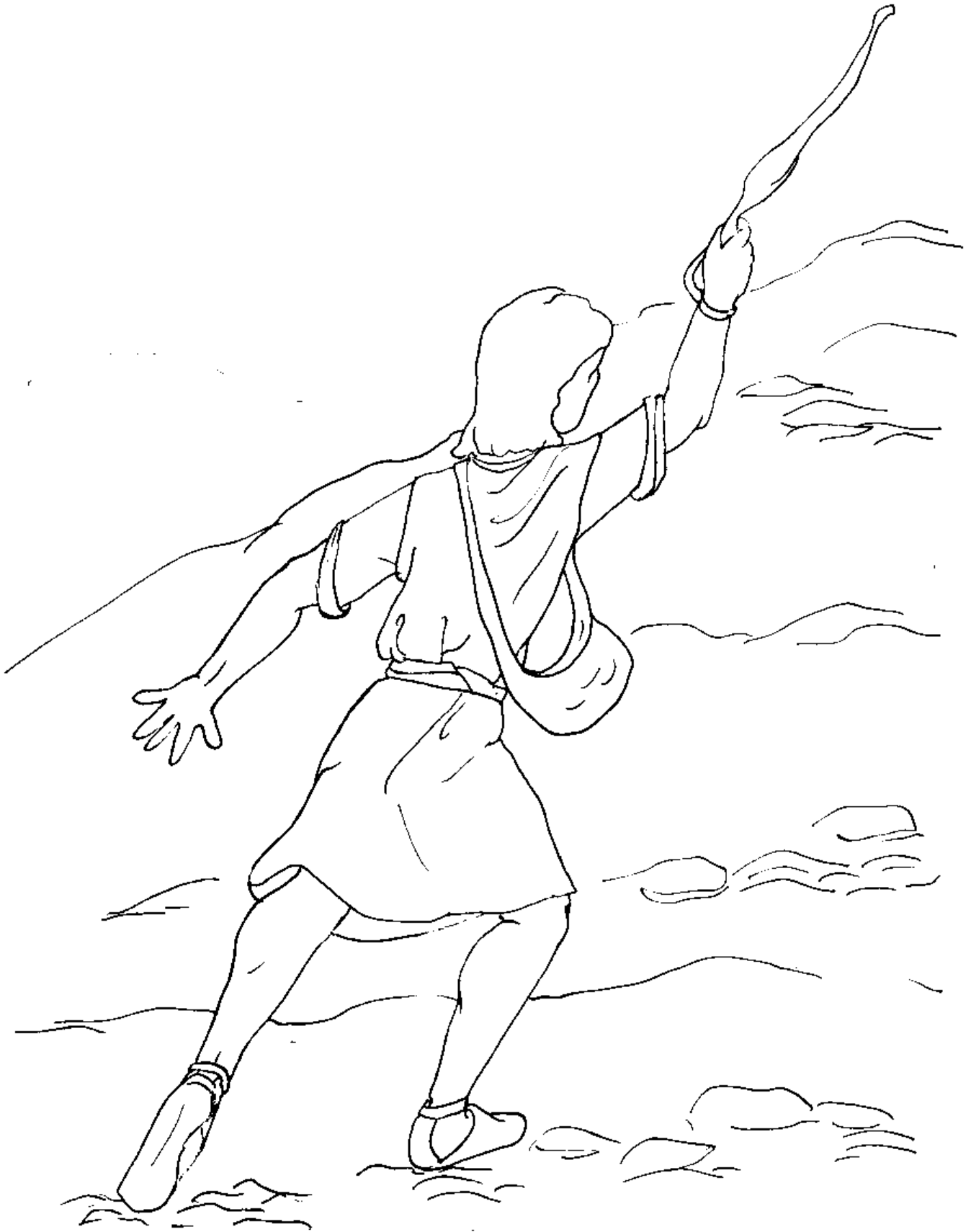

# David Kills Goliath



# Saul Throws a Spear at David but Misses



# David and Jonathan Embrace and Weep



## Sling Shot Craft Example

# DAVID SLAYS GOLIATH

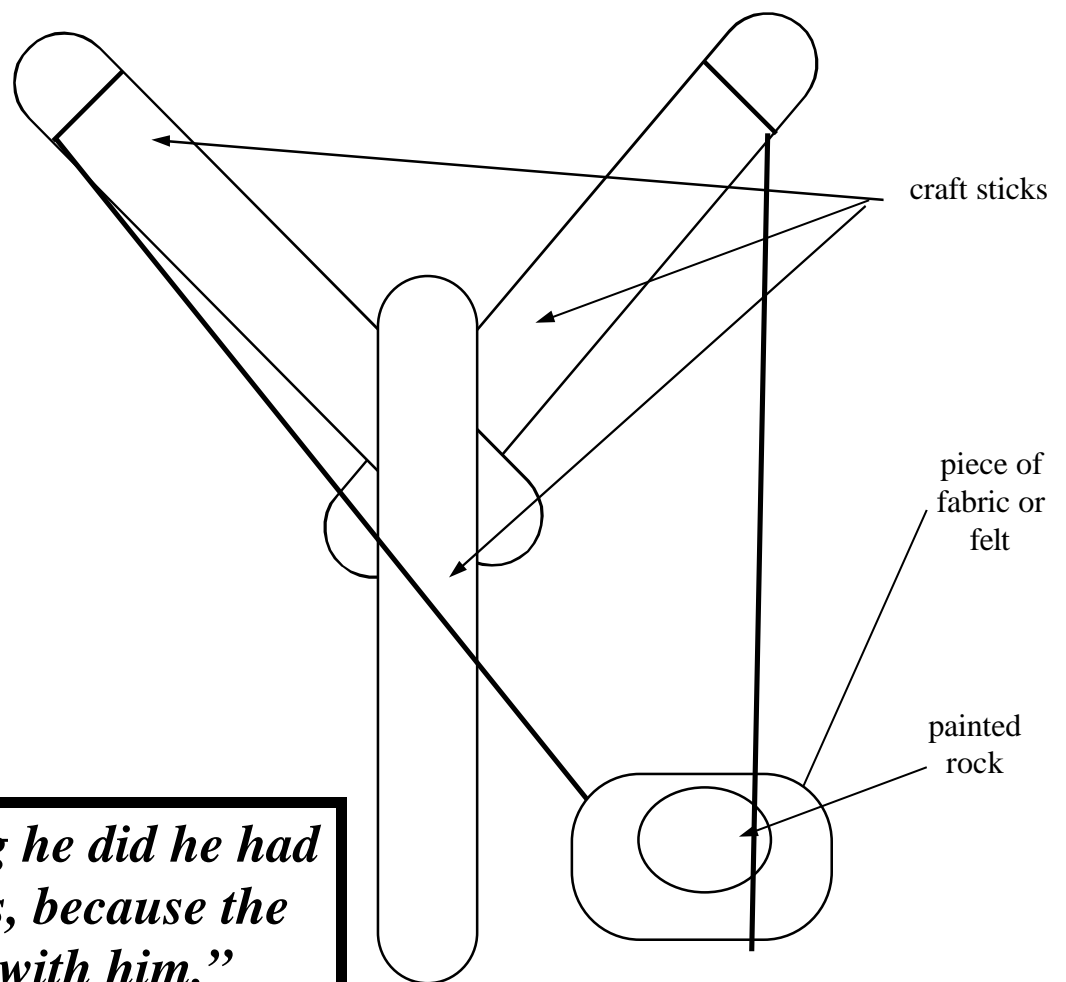

*“In everything he did he had great success, because the LORD was with him.”  
1 Samuel 18:14*

**DAVID SLAYS GOLIATH**

**DAVID SLAYS GOLIATH**

**DAVID SLAYS GOLIATH**

**DAVID SLAYS GOLIATH**

**DAVID SLAYS GOLIATH**

**DAVID SLAYS GOLIATH**

*“In everything he did he had  
great success, because the  
LORD was with him.”  
1 Samuel 18:14*

*“In everything he did he had  
great success, because the  
LORD was with him.”  
1 Samuel 18:14*

*“In everything he did he had  
great success, because the  
LORD was with him.”  
1 Samuel 18:14*

*“In everything he did he had  
great success, because the  
LORD was with him.”  
1 Samuel 18:14*

*“In everything he did he had  
great success, because the  
LORD was with him.”  
1 Samuel 18:14*

*“In everything he did he had  
great success, because the  
LORD was with him.”  
1 Samuel 18:14*

# Who Really Has the Power?



Let's take a closer look at who really has the power. This worksheet will take some help from your parents and other family members. Use the clue verses provided to find the best word in your NIV Bible to solve the puzzle. Look up the verses and try to find the appropriate words that fit. Be careful because some of the verses may have more

“ (Prov. 3:6) _____	(Gen. 6:17b) _____	(John 3:16) _____	(2 Sam. 5:25) _____	(Ps 24:2) _____	(Ps. 94:17) _____
(Matt. 5:19) _____	(Josh. 1:8b) (form of the word) _____,	(Luke 4:18) _____		(Gen. 1:1) _____	
(Jer. 26:19a) _____	(John 1:1) _____	(John 1:1) _____	(Luke 11:10b) ”” _____		

# Maze to Success

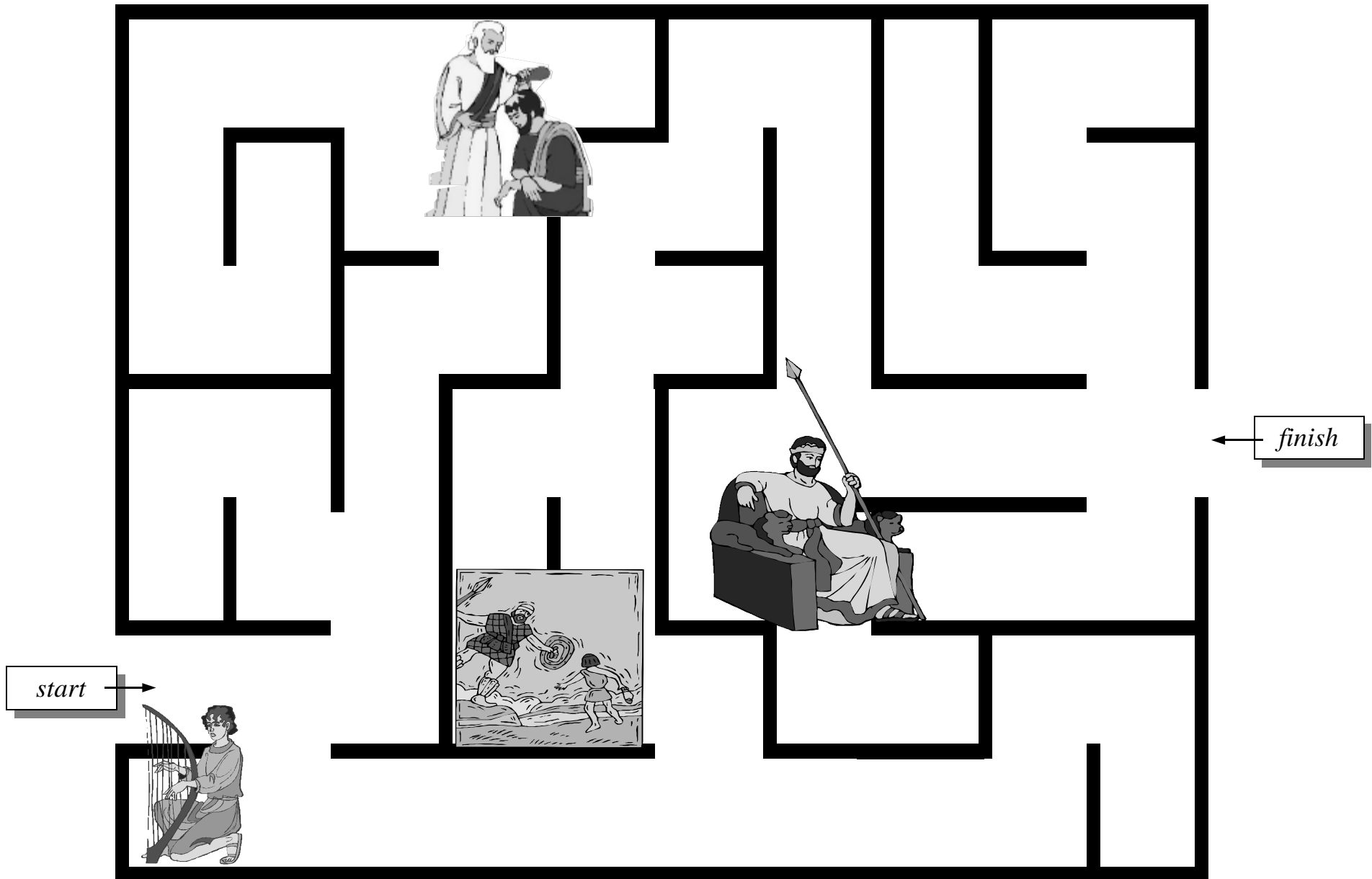

# Aim Questions

Answer the following questions about today's Bible Adventure.

1. Who did Samuel originally think was God's choice to be the next king of Israel? Why?
2. Why did God choose David over his older brothers?
3. What were some of the key battles David fought in that God gave him great victory?
4. What did Saul think of David's growing success in Israel?
5. What did Saul then try to do to David?
6. Why did Saul always fail to hurt David?
7. What are some things that you've personally learned from

*Do you give the Lord the thanks and praise that he deserves for every success in your life?*

**1**  
**Samuel**  
**16-20**

"Man looks at the outward appearance, but the LORD looks at the heart."  
1 Samuel 16:7b

which showed his allegiance and great love for David? 10:4, 13

What did Saul, in his anger toward David, say to Jonathan?  
20:31

What did he try to do, in anger, to his own son? 20:33

After Jonathan and David wept together, what did Jonathan say to David that bound them together forever? 20:42

## **Passage Review Questions**

### **1 Samuel 16 - 20**

What did the Lord tell Samuel to do after He had rejected Saul as king of Israel? 16:1

What was Samuel afraid that Saul would do to him if he found out what he was going to do for the Lord? 16:2a

What was the Lord's solution for this problem? 16:2b

When Samuel arrived in Bethlehem, whom did he call to the sacrifice? 16:4,5

Name the three oldest sons of Jesse. What did the Lord say to Samuel about them? 16:6-10

Jesse had one more son who was not at the sacrifice. Who was he, and where was he during this time? 16:11-12

When David was called before Samuel, what did the Lord have Samuel do to David? 16:12b,13

What happened to Saul when David was anointed by Samuel?  
16:14

Saul's servants suggested that he have someone come play the harp for him so that his suffering could be eased. Who was found to play the harp? 16:18

What did Jesse send with David when he sent him to Saul?  
16:20

Was Saul pleased with David's playing? What was David appointed to do? 16:21-23

The Israelites and Philistines camped opposite each other. What was between the two camps? 17:3

Describe Goliath and draw what he might have looked like next to an Israelite. 17:4-7

What did Goliath shout to the Israelites? 17:10

How did Saul and the Israelites feel after hearing Goliath's words? 17:11

What was David delivering to his three oldest brothers in Saul's army? 17:17-18a

David convinced Saul to allow him to fight Goliath. What did David take with him? 17:40

In whose name did David fight? Whose battle was it that David was fighting? 17:45, 47b

Who came out singing praises of David, and how did Saul feel about this? 18:6-9

Whose daughter did David marry, and how did she help him?  
18:27;19:11-12

What did Jonathan, Saul's son and David's friend, say to David

To play the game: 1 die and a game piece for each player is needed. Roll to see who will go first. Follow the directions of the square that you land on and have a great time.

# 1 Samuel 15 - 20 Game



<b>START</b>	David is anointed. Move forward 3 spaces.	Saul is rejected as king. Go back to Start.	David gathers 5 smooth stones. Trade places with any player.	David plays the harp for Saul. Sing a song and move forward 2.
David tries on Saul's armor. Miss a turn.	David protects Saul. Tell of a time when you were protected.	David tries to kill David. Go back 5 spaces.	David defeats Goliath. Do a victory dance and roll the die again.	David, the youngest, is chosen. Let the youngest player move forward 2.

Saul is jealous of David. Tell of a time when you were jealous.	Saul is tormented by an evil spirit. Miss a turn.	"In everything he (David) did he had great success..." Go to the square that finishes this verse. (Hint: 1 Sam. 18:14)	God is with David. Roll again.	David, the youngest, is chosen. Let the youngest player move forward 2.
--	--	--	-----------------------------------	--

		<p><b>FINISH</b> To learn more, see 1 Sam. 15-20</p>
--	--	--

<p>Look up 1 Sam. 16:7 and read it aloud. Move forward 3 spaces.</p>	
--	--

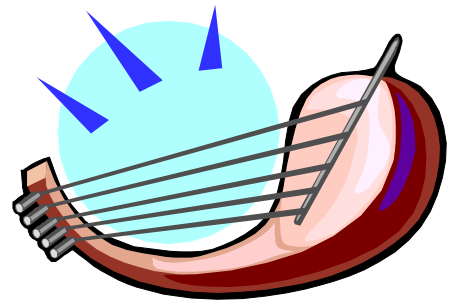

	<p>God uses David's difficulties to prepare him to be the king.</p>	<p>Jonathan protects David. Roll again.</p>	
--	---	---	--

		<p>“...because the LORD was with him.”</p>
--	--	--

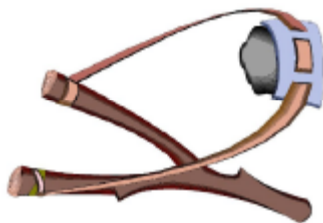

<p>Goliath defies God and curses David. Go back to Start.</p>	<p>David wins many battles. Move forward 2 spaces.</p>	<p>David flees from Saul. Trade places with the oldest player.</p>		<p>David and Jonathan become best friends. Tell about your best friend.</p>
---	--	--	--	---

# *Centerpiece of Success*

Today your child learned that every success comes from the Lord. To help him or her remember this in the coming week, your child may draw a picture of a success he or she has each day (learning a new skill, using good manners, etc.). The picture box may be cut out on the lines and pasted to the calendar.

Use the calendar as a table centerpiece and discuss the successes of each family member.

Thank the Lord for every success, both large and small, that He has given your family that day.

MONDAY	<b><i>EVERY SUCCESS COMES FROM THE LORD</i></b>	TUESDAY
WEDNESDAY	THURSDAY	FRIDAY

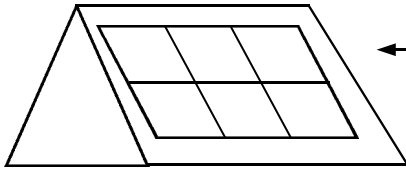

View of completed centerpiece. Picture of David's success on the other side.

Draw your own picture in the box below of a success that God gave David. Cut out and glue on the opposite side of the calendar.

*"In everything he did he had success, because the LORD was with him." 1 Samuel 18:14*

# Successful Sailing

Make a sailboat using one of the sails below, a bottom half of a paper cup, straws, tape, toothpicks, and clay or sticky-tack.

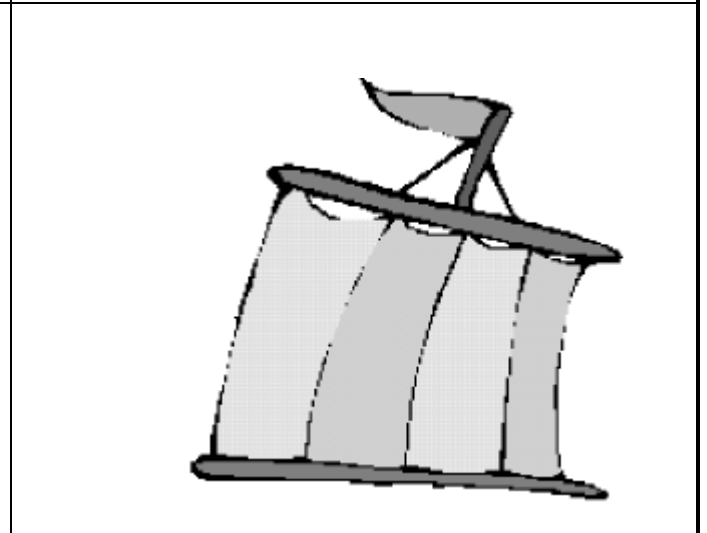
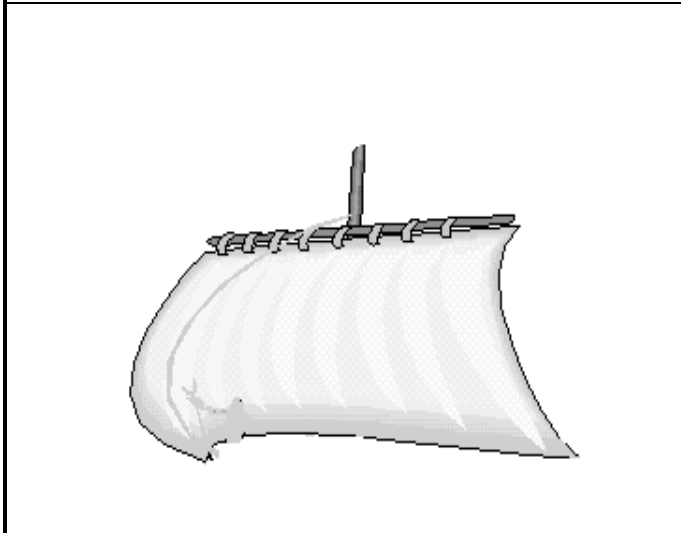
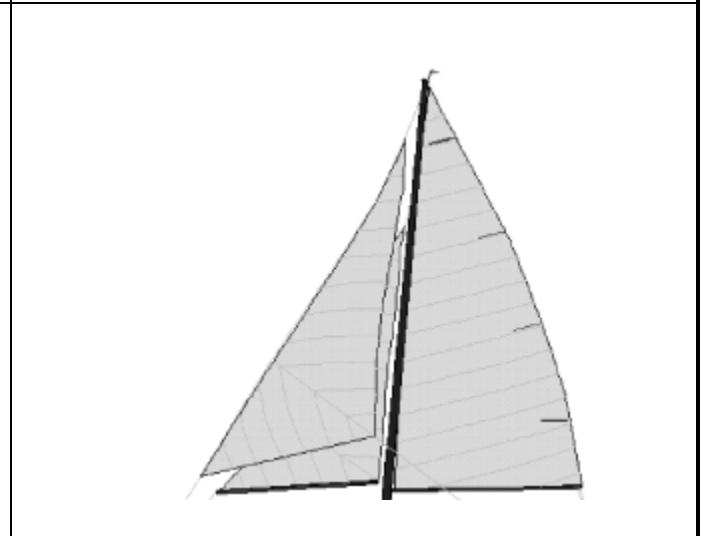
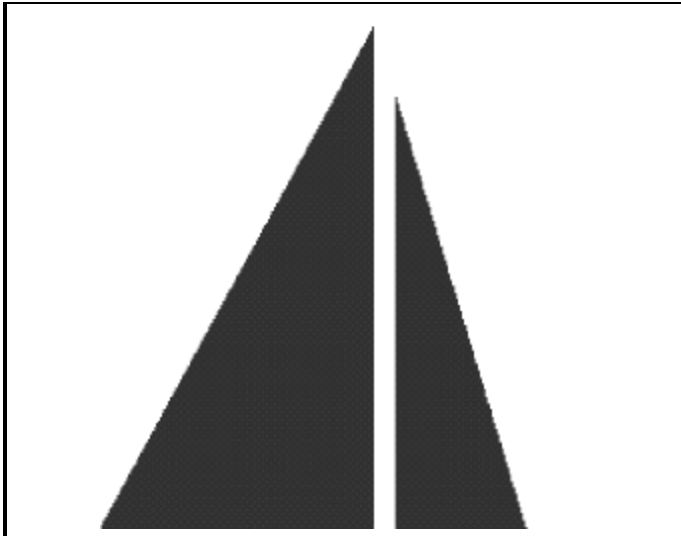
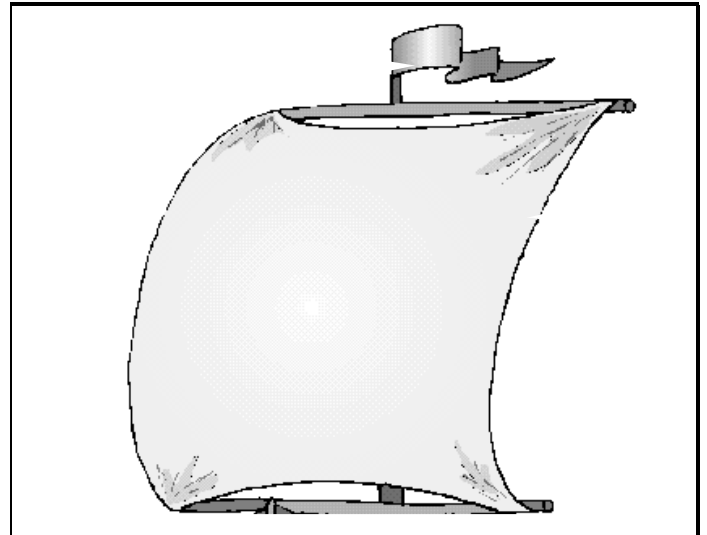
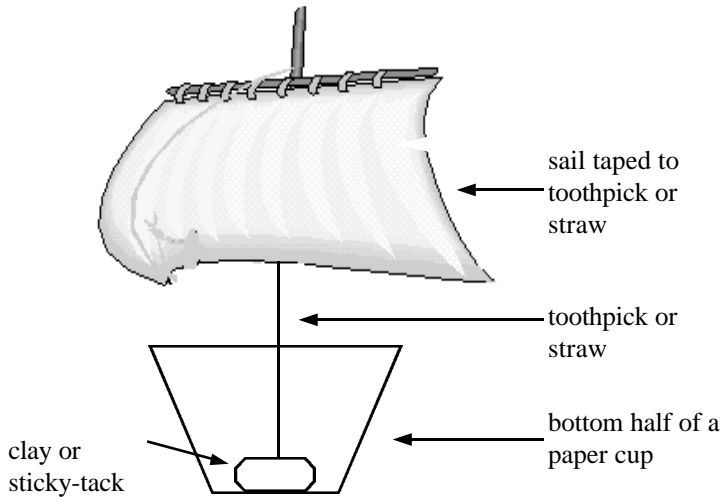



**Thanking God Daily For His Faithfulness To Me**



*“In everything he did he had great success, because the LORD was with him.”  
1 Samuel 18:14*

## Thanking God For His Faithfulness to Me Stickers

Color these stones and use them this week on your placemats for your family. As you thank God for the successes you have had each day, add one stone to your placemat. It only took one stone for David to

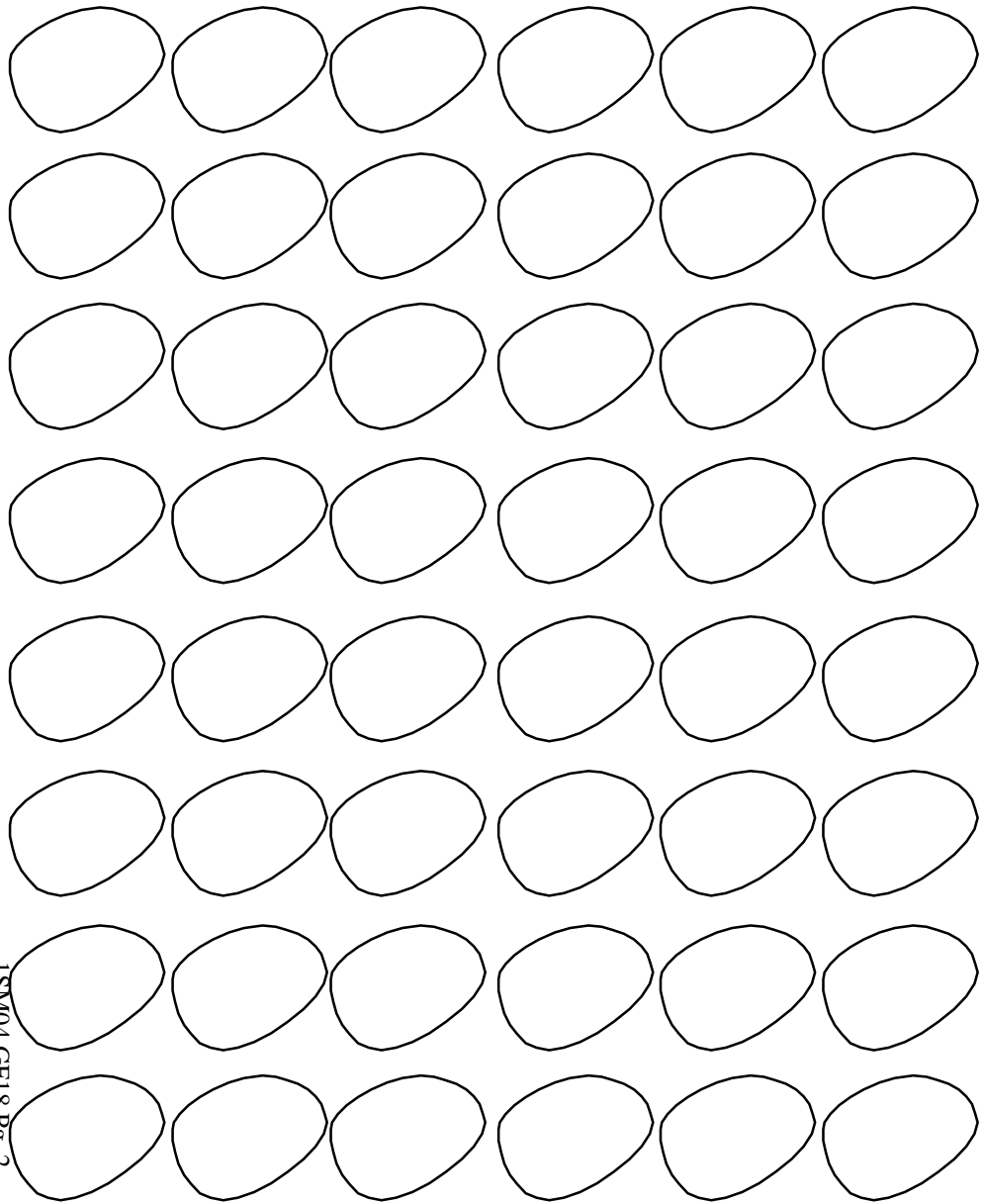

## Thanking God For His Faithfulness to Me Stickers

Color these stones and use them this week on your placemats for your family. As you thank God for the successes you have had each day, add one stone to your placemat. It only took one stone for David to

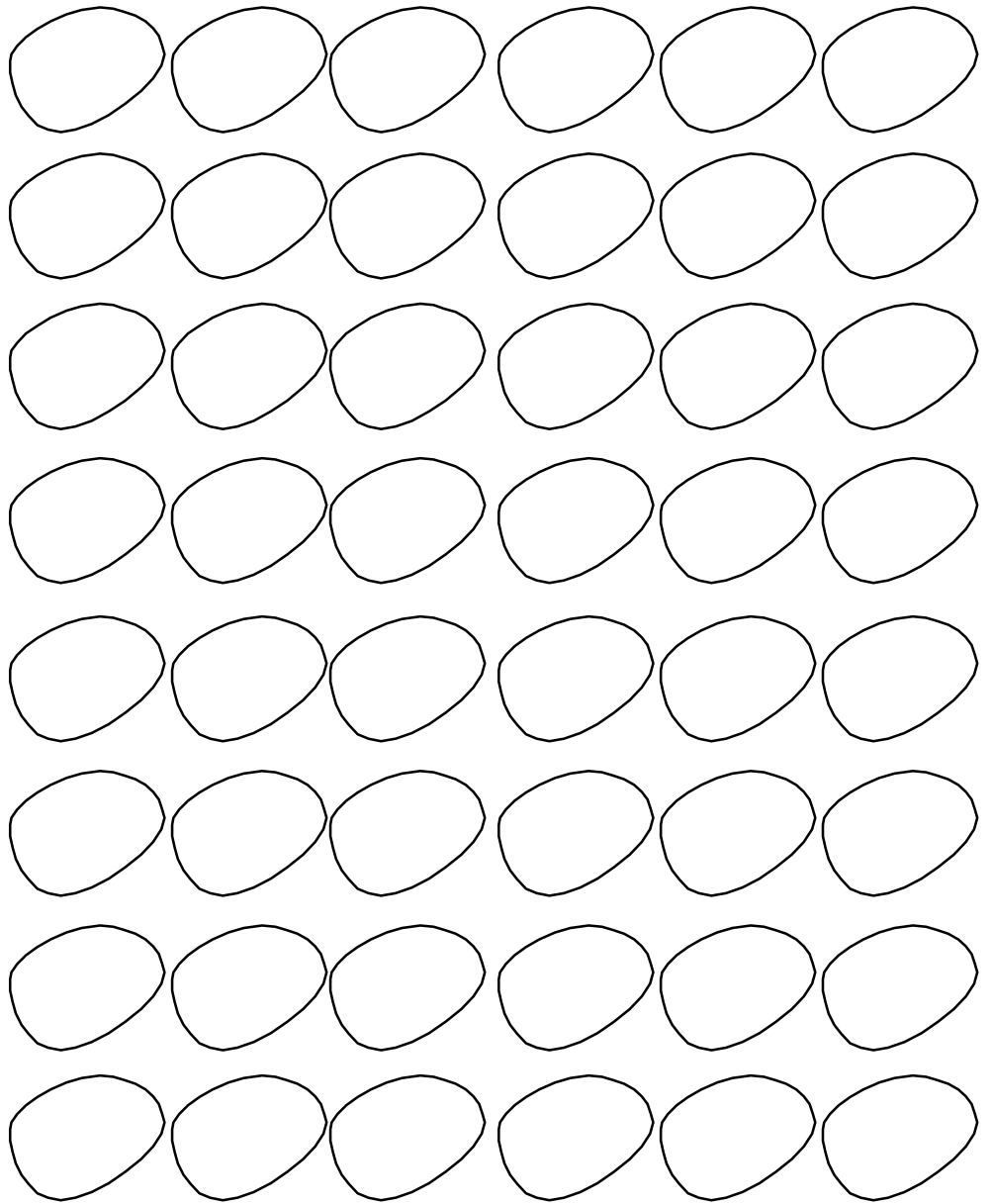

# PLAY

## Paper Puppets:

After you have read the story, have each child make a paper puppet and reenact the story. Using brown sandwich bags or socks, decorate them to be the following characters: David, Goliath (a parent may need to make and be this one), Saul, Jonathan, and Michal.

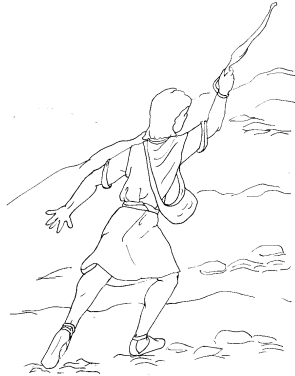

Pull out the couch for a puppet stage for your children to sit behind as they practice the the story. Break the play down into the following scenes:

1. David convinces Saul that he can fight Goliath.
2. David kills Goliath.
3. David and Jonathan become friends.
4. Saul becomes jealous of David.
5. Michal, David's first wife, helps David escape from Saul.

After the play is over, discuss who had godly attitudes and who did not.



FAITH BIBLE CHURCH

# FAMILY FUN SHEET

11/05/2000

This is what we learned today:

**Passage** ~ 1 Samuel 16-20

**Memory Verse** ~ "Man looks at the outward appearance, but the LORD looks at the heart."

1 Samuel 16:7b

**Application Points** ~

- ◆ The Lord looks at the heart.
- ◆ Don't focus on outward appearances to please men but on a heart that pleases God.
- ◆ Success comes from the Lord.



## Music for worship and memory

One of the most overlooked treasure chests of encouragement and praise comes through hymns. If your family doesn't own a hymnal, go to a used bookstore and find one. Surprisingly, the older tunes that seem outdated for our tastes are quite easy for children to learn. Many of them contain rich and deep truths. Buy a tape or CD if you are not musically inclined.

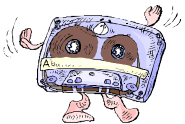

## Children's Tapes

Children's ministry has been putting together tapes with the Bible Adventures, memory verses, and songs. Kids love them and learn the stories very well. The songs are helpful for the whole family in memorizing Scripture.

## PRaise

**1 Samuel 16:7b Song:** (Tune: "Fairest Lord Jesus")

The Lord looks at the heart. (Fairest Lord Jesus,  
But the Lord looks at the heart. (Ruler of all nature,  
First Sam-uel sixteen verse seven b (O thou of God and man the Son;  
The Lord looks at the heart. (Thee will I cherish,  
The Lord looks at the heart. (Thee will I honor,  
First Samuel sixteen, seven b (Thou my soul's glory, joy, and crown.)

**Be Thou My Vision**

Be Thou my vision, O Lord of my heart;  
Naught be all else to me, save that Thou art:  
Thou my best thought, by day or by night,  
Waking or sleeping, Thy presence my light.

## PASSAGE

**Daily Bible Reading:** The following passages are some of the most popular children's stories of the Bible. Take the time this week to read the whole account. Most children's versions leave important details out.

**Day 1:** Chapter 16

**Day 2:** Chapter 17

**Day 3:** Chapter 18

**Day 4:** Chapter 19

**Day 5:** Chapter 20

**Family Bible Night: 1 Samuel 17:31-58; 18:10-30**

The Philistines again attacked Israel. They had what seemed to be an invincible soldier, a giant by the name of Goliath. Saul and the rest of the Israelite army were trembling because they feared that no one in their camp could beat the Philistine giant. While Goliath mocked the Israelites as well as the Lord, David happened upon the scene as he brought food to three of his older brothers who were in the army. When David, who was but a teenager, heard the words spewing out of Goliath's mouth, he could hardly contain himself! He wondered who this filthy-mouthed Philistine was.

After convincing King Saul of his willingness, David was given permission to take on the giant. When David approached Goliath, Goliath felt insulted that Israel would send out a youth to fight him. But David was not afraid or deterred in his mission. He shouted to Goliath, "All those gathered here will know that it is not by sword or spear that the LORD saves; for the battle is the LORD's, and he will give all of you into our hands" (17:47). With that, he pulled out a stone and placed it into his sling, and he threw it right into the forehead of Goliath. The giant fell to his death and the Lord gave David and Israel a great victory that day over their archenemies.

Word spread throughout Israel that this young shepherd boy named David was the hero of the war. David's acclaim brought on much jealousy in Saul, and from that day forward, he desired to take David's life. In fact, Saul tried to kill him on 20 different occasions! Saul tried desperately to send David out into the fiercest wars, hoping that David would be killed in battle. But the more David went out leading the troops, the more he won. There was nothing Saul could do to harm David because the Lord was with David. And since God was with him, he found success in all that he did.

As Saul's anger toward David grew, it became obvious that David needed to depart from the kingdom in order to spare his own life. On one occasion, Saul personally tried to kill David by hurling a spear at him, but David escaped. Later that night, Saul sent messengers to watch David's house so that he could kill him in the morning. But David's wife helped him escape out a window in the middle of the night.

## PERSONAL APPLICATION

### ***The Lord Looks at the Heart***

Unlike the nation of Israel, God's choice for their king was vastly different from Saul. In Saul, the nation had a very tall and handsome man, but one who lacked a heart of obedience to God. They focused merely on Saul's outward appearance. But in David, God chose a man after his own heart who genuinely loved Him. This tells us that God's measure of His people is not based upon their outward appearance, but upon their inward character. Regardless of how we look on the outside, we can grow in our love for God in our hearts. This is a comforting truth to hold onto in a day when so much emphasis is placed upon our looks!

### ***Success Comes from the Lord***

One of the key truths Saul failed to understand was that success comes from the Lord. Even though he desperately tried time and time again to take David's life, he couldn't because God was protecting David and granting him victory over Israel's enemies. When we stand by the Lord's side and trust in His Word, we will have success (Psalm 1:1-3).

### **Application Questions:**

- ◆ What does loving God from the heart look like?
- ◆ How do we develop a heart to please God, not men?
- ◆ For what successes in your life do you need to give God thanks?

## PRAYER

### **Growing in Trust and Thankfulness**

**Trust:** As you pray to God with your children, praise Him for those attributes which instill trust. Praise God for His faithfulness, patience, goodness, and love. You may even teach your older children to pray Scripture for each other such as Proverbs 3:5, 6 and Ephesians 3:16-19.

**Thankfulness:** We often think we accomplish things because of intelligence or strength, but all abilities come from God. Thank God for ways in which He has helped you to be successful. Things such as obedience, a good score on a test, or even purchasing something comes from the hand of God. Be thankful for as many things as you can think of.