

*Hope for the Future*

**Materials I Need:**

**Legend:**



= Option 1, Appropriate for 1<sup>st</sup> – 2<sup>nd</sup> Grade



= Option 2, Appropriate for 3<sup>rd</sup> – 6<sup>th</sup> Grade



**Memory Work:**

“Be joyful always; pray continually; give thanks in all circumstances, for this is God’s will for you in Christ Jesus.” 1 Thessalonians 5:16-18





**Hook:**





**Clouds (Visual Aid/Discussion).**   Decorate the walls and ceiling of the room with clouds. Ask the students what they think of when they think of clouds. What do they know about clouds? Have a large cluster of white helium balloons in the room (balloon cloud - - tell the students to wait and see what will happen with this balloon cloud later). In today’s Bible adventure, they will hear something very exciting about clouds that they may not have heard of before.





**Anticipation (Discussion).**   Ask the students if they have ever been excited with the anticipation of something that they knew would happen but didn’t know when. What? (If they don’t come up with ideas on their own, suggest snow, an airplane carrying someone they knew, a baby, a package or letter, shooting stars, catching a fish). How did they feel while waiting? How did they feel when the expected event actually arrived? Explain that today they will hear about something that all Christians should be excitedly expecting and watching for...something much more wonderful and exciting than anything else!





**Get Ready #1 (Worksheet/Discussion).**   Give the students a copies of **1TH03.GF1**. Ask them to write or draw pictures of things that they will need in order to be ready to go somewhere. Draw an outline of a suitcase on the whiteboard and call upon the students to come up and write/draw one thing they have in their suitcase. Tell them that today they will hear about what the Bible says they need to be ready to go to a very special place and they will want to be ready!



**Between a Hope and a Wish (Skit).**   Set up the temporary divider walls to look like two adjacent jail cells. Use other props like benches and long curtain rods to look like bars. Perform this skit to hook the students with the understanding of the true hope that Christians have in Christ. Nelson’s Bible Dictionary states, “Genuine hope is not wishful thinking, but a firm assurance about things that are unseen and still in the future (Rom. 8:24-25; Heb. 11:1,7).” Contrast wishful thinking with certain expectation in this short drama. Have a man escorted into cell-A. While this man anxiously settles into his cell, have a second man escorted into cell-B. As both adjust to their uncomfortable abode, send in a guard with a bail notice to the man in cell-A. This man’s countenance will change with the news that his father is paying the bail for his release the next day. The man in cell-A will express his confidence in his father’s word and will demonstrate comfort in the certainty of his future release, sleeping happily in his cell that night. Meanwhile, the man in cell-B will continue in anxiety demonstrating only wishful thinking, frequently muttering an uncertain hope that someone will bail him out as well. Discuss the difference between these two hopes with the students. Explain the hope Christians have of heaven and tell the students to look out for this kind of hope in today’s Bible lesson.

 **No Sorrow for the Saved (Discussion).** 🍌, 🦋 Ask your students if they have had a family member, such as a grandparent, aunt, uncle, or cousin, die in the last few years. Ask them if they were sad when that family member died. Explain that we are always sad when someone dies because we miss being around him or her. Ask the students if they think they will see those loved ones again. Students will likely say that they will see them in heaven. Ask them how they know that they will see them in heaven. Discuss with the students the fact that we are sad when someone dies, but if that person knows Jesus as his or her Lord and Savior, we will see them in heaven. Tell them that we don't need to be sorry for those who die who know Christ. We will see them again.

 **Who Is Coming? (Activity).** 🍌, 🦋 As the students arrive, act as if you are very excited because someone very special is coming. Build up the anticipation in your students by asking them if they have ever had to wait to see someone special like a grandmother or grandfather. Did they think about how it would be once that special someone arrived? Did they make plans as to what they would do once they were together? Ask them who they think today's special someone might be. Don't tell them that this person is coming this morning, only that it could be at any time. Keep the anticipation going throughout the morning. At some point in time, have a surprise visitor come into the classroom and pass out special treats. After this special guest leaves, talk about how exciting it was to wait and hope that this special visitor would come soon, and explain that we should have great anticipation and hope for the return of Christ. When He returns for His children, it will be a lot better than just getting a treat.

 **Family Reunions (Discussion).** 🍌, 🦋 Discuss with the students how summertime is often the time when families get together to see each other. Relatives from all over often come to one location and stay for several days. This is called a family reunion. The time together is spent catching up on things each family has been doing, and getting reacquainted with those they have not seen in a long time. It is a chance for cousins, aunts, uncles, and grandparents to be together again after a long separation. Some families have reunions each year, others only have them every five years or so. Ask the students if their family has ever been to a reunion. Was it fun to see relatives they hadn't seen in a long time. For those who have reunions each year or so, don't they get excited once the time draws near? Don't they long to see those loved ones whom they have not seen in a long time? If you, as the teacher, have been to a family reunion, you may want to bring in photos to show your students. Tell the students that, in the Bible Adventure this morning, they will hear about another kind of family reunion. One we as believers can look forward to. When we get to heaven, we will be reunited with those fellow believers who have gone before us. How great that will be to be reunited with our loved ones!



### Book:

#### Presentation Ideas –

 **Believers Meet Christ in the Air (Illustration/Coloring Page).** 🍌, 🦋 1 Thessalonians 4:17, 1TH03.GF2.

 **Future Things (Chart).** Use this chart to help the students understand the events described in the Bible that will happen prior to and after the second coming of Jesus Christ, 1TH03.GF3.

#### **Bible Adventure for K-2<sup>nd</sup> Grades–**

Even though Paul was able to spend only a short time with them, God had done an amazing work in the Thessalonian church. Others soon heard of their great faith, hope, and love. They stood firm in their faith even in the face of intense persecution. They were not a perfect church, but they continually grew in their obedience to God's Word. Paul had sent his young disciple, Timothy, to find out how they were doing. When Timothy reported back, Paul rejoiced because of God's work in the life of the Thessalonians. However, Timothy also told Paul about some of the struggles they were having in their everyday lives, such as remaining pure in their conduct, working hard at their jobs, and being faithful in loving others.

Paul exhorted the Thessalonians to keep on living lives that were pleasing to God. They were not to live like the people around them, who acted like they were married to several different people instead of to

just one husband or wife. Paul told them in 1 Thessalonians 4:4, “Each of you should learn to control his own body in a way that is holy and honorable.” He wanted them to believe in a way that protected the purity of each one. Paul encouraged them to keep on showing their love for one another.

Paul also urged the Thessalonians to keep on working hard at their jobs. One problem was that some of them had stopped working because they thought Jesus was going to come back for them soon. This meant that they were not making money to pay their bills. This was not a good witness to the non-Christians around them. Christians should not be known for begging and not paying their bills. They should work hard when work is available.

Because Paul had so little time to spend with the Thessalonians in person, he didn’t get to teach them all he wanted to about the future. The Thessalonians were not sure what happened to believers after they died. They had suffered much at the hand of their enemies and were grieved for those who had died for their faith. They wanted to know if there was life after death.

Paul took this important opportunity to teach them about their future hope in Christ. He began by telling them that they could have hope because Jesus rose from the dead. If Jesus rose from the dead, then God will raise everybody who has died believing in Jesus. How will this happen and when? When Christ comes back, “the dead in Christ will rise first” (4:16). Then those who are still living will also be caught up to Christ. What an incredible hope! Loved ones who have died will be physically united with Christ and so will we. One day Jesus will return to rule the earth. Before He does, He will come down from heaven and there will be a loud shout and a trumpet blast for all to hear. At that moment the dead will be raised up first and given their physical bodies. Right after that, all who are still living will be raised up right through the air (4:17). What an incredible event! Those living at the time won’t die. They will be brought right to Jesus. This event is called the rapture. At the rapture all the dead and the living believers will be brought together. This truth gave the Thessalonians enormous hope and helped them endure the terrible persecution from those who hated Christians. One day they would be united with loved ones who had died.

Paul praised the Thessalonians for their faith and love, yet he still wanted them to become even more like Jesus. He wanted their behavior and thoughts to become more and more holy. He urged them to behave in a way that was pure and loving toward others. Can you say that you are becoming more and more like Christ each day?

Also, are you concerned about what will happen to you after you die? The greatest hope we Christians have is the hope of heaven. When Christ comes back, all those who have died and those who are still living will be brought together to meet Christ in the air. Then we will be with the Lord forever! Do what Paul commanded in 1 Thessalonians 4:18, “Encourage each other with these words.”

### ***Bible Adventure for 3-6<sup>th</sup> Grades—***

The church planted by the Apostle Paul in Thessalonica was pretty amazing. The believers were known all through the area for their love and their boldness in telling others about Christ. They continued in these things in spite of people working against them, trying to discourage or stop them altogether. The Thessalonians were not a perfect church, but they were putting what they knew of God’s Word into practice, and they were growing.

You remember that Paul was forced to leave Thessalonica suddenly and was not able to return, but he sent Timothy after some time to see how the new church was doing. When Timothy reported back to him, Paul was very glad to hear how well the Thessalonian believers were doing. But it was not a perfect picture—they were having some struggles, too. Our day-to-day living is where we see if we are walking in the Spirit, being obedient to God, or walking in our flesh, doing what pleases us. This was true for the Thessalonians, too. It’s tough, day after day, to treat others well and love our families, friends, and schoolmates. The Thessalonians struggled with staying pure, working hard, and being faithful in loving others. In chapter four of 1 Thessalonians, Paul began to encourage them to deeper holiness and love. He also taught them about their future hope in Christ.

Paul began his teaching by pleading with the Thessalonians to keep doing what they were already doing, living to please God. They were to keep pursuing holiness. One of the big struggles Timothy had told Paul they were having was living pure lives. In Greek culture it didn't matter whether a person stayed pure or not--much like here in America today. The new Christians were learning what it meant to be pure with their bodies. Paul told them in 4:4, "Each of you should learn to control his own body in a way that is holy and honorable." They should treat each other in a way that protected the purity of their brothers and sisters. They should not behave as if they were married when they were not. Paul also encouraged them to continue to learn even more about how to love one another. Paul praised this church for its faith and love. Still, he wanted them to become even more like Jesus. We should never be content that we have "arrived" spiritually. There is always more growing to do. What about you? Are you growing in purity in your thoughts and attitudes? Are you protecting the purity of others and growing in your love for others?

There was another big problem in the Thessalonian church. Some of the people were not working very hard. Paul had told them that Jesus was coming back so some of them stopped working in order to wait for Him. This meant that they were not making any money to pay their bills. This was not a good witness to the outside world. Christians should not be known for not paying their bills. They should work when there is work to be had.

Even though Paul was in Thessalonica only a short time, he was able to teach people that Christ would return to earth one day for all His followers. These believers looked forward to that day and thought it would happen very soon, probably in their lifetimes. They knew that day would be grand and glorious. But many of them were troubled because they had seen Christian friends and family die and were sad because those friends and family would miss seeing Christ return. The Thessalonians were not sure what happened to believers when they died. Did they die too early to be brought to heaven when Christ returned? Would they just stay in the grave? This is what some of the Thessalonians thought. After all the suffering they had gone through, they were sad about those who had died in the faith. What use would it be to face this persecution if there were no life after death?

Paul gently began to teach them about their future hope in Christ. In verse 13 he said, "Brothers, we do not want you to be ignorant about those who fall asleep [that means those who died]." Paul wanted them to know the truth--that they could have hope because Jesus rose from the dead. Yes, Christians will feel sad when they lose someone they love. But if the person who died was a Christian, Paul said, they should not have the kind of sadness the world has at such a time--sadness because there is no hope. The Thessalonians believed that Jesus rose from the dead. Paul wanted them to go one step further and know that God will raise everybody who dies believing in Jesus (4:14). How will this happen and when?

One day Jesus will return to rule the earth. When Christ comes back "the dead in Christ will rise first" (4:16). Then those who are still alive will be caught up to Him. What an incredible hope! Those who we love and who love Christ will be physically united with Him, and so will we! Jesus will come down from heaven and an angel will give a loud shout and everyone will hear a trumpet blast. At that moment the dead will be raised first and given their new bodies. Right after that, all whom are still living will be raised up right through the air (4:17). What an awesome event! Those living at the time won't die but will be brought right to Jesus. This event is called the rapture. At the rapture, all the dead and living believers will be brought together. Imagine the hope this gave the Thessalonians. This was what would help them go through such terrible persecution. Those who had died as Christians and those who were still living when Christ returned would be reunited. They would see their dead friends and family again--all would be gathered around Jesus Christ.

What a hope we have in the hope of heaven! It's a treasure no one can take from us. When a believer dies he will go to heaven, and those Christians who never have to go through the experience of dying will be taken up by Christ to be with Him forever. When you consider that this life we spend on earth is like the blink of an eye compared to eternity, it makes it easier to go through suffering. Even though we're sad when we lose someone we love, if they knew Christ, we know we will see them again. Thank God today that He's given you a future and a hope.

### Aim Questions:

1. **What did Paul want the Thessalonians to do concerning their daily Christian life?** (*Grow in holiness, love, and labor.*)
2. **In what part of holiness did Paul especially want them to grow?** (*Purity.*)
3. **What is the great hope of the Christian?** (*He will be united with Christ after death, or Christ will come back to earth.*)
4. **How is that a comfort when thinking about friends and family who have died as Christians?** (*Those people are with Jesus. We will all be together with Jesus someday.*)
5. **Why do Christians need to grow in their love?** (*To be more like Christ.*)
6. **How can you live like there is hope for the future?**



### Look:



**Get Ready #2 (Worksheet/Discussion).** 🐛, 🦋 Give the students copies of **1TH03.GF4**. Ask them to look up the listed verses and write what the Bible says they need to be ready for Christ's return.



**The Rapture (Worksheet).** 🐛, 🦋 Have the students take a look at what the Bible says about the rapture. We do not find the word "rapture" in the Bible. However, being "snatched away" comes from the Latin word "rapio" or "rapere." This is the root of the word "rapture." In the Bible Adventure today, the students will hear about what will happen with believers in Christ when He comes again. Just when is He coming? And what will it be like? What will we be like? There is a lot of evidence that shows that, when Christ comes back, believers will rise up and be "caught up together with them in the clouds." What does that mean? We can't even imagine what it will be like, but God's Word gives us clues. Even though this sounds impossible, 2 Timothy 3:16 reminds us that "all Scripture is God-breathed," so that we can trust what the Bible tells us. Using **1TH03.GF5**, have the students fill in the missing words of the verses listed in their NIV Bible, to see what God has to say about this great event.



**Jesus Is Coming Again Pop-Up Card (Craft).** 🐛, 🦋 Duplex copy the front cover, **1TH03.GF6 Pg. 1**, and the cloud page **1TH03.GF6 Pg. 2** onto cardstock. Copy the Jesus figure on **1TH03.GF6 Pg. 3** onto white paper for each student and have them follow the steps below to complete their pop-up cards:

1. Carefully fold the cover and cloud page in half to form a booklet.
2. Carefully cut out the Jesus figure along the outside lines.
3. Fold the Jesus figure in half lengthwise with the figure on the outside to make a fold line. Then unfold and press the figure flat again.
4. Fold the tabs on the Jesus figure up to make tab fold lines. Then unfold and press flat.
5. Apply paste to the back of the tabs and attach the Jesus figure to the cloud page, making sure that the fold line of the figure aligns with the fold line of the cloud page.
6. Fold the booklet together and press flat.

Use this craft to emphasize that when Jesus comes back He will not be on earth but in the clouds above the earth. All those who are true Christians will go from earth to meet Him there.



**Verses of Hope (Worksheet).** 🐛, 🦋 Have the students look up the verses listed and fill in the missing word(s), **1TH03.GF7**.



**God's Will for You (Puzzle).** 🐛, 🦋 Have the students find the memory verse by going down one column and up the next. Have them write the letters in the space provided and then answer the question, **1TH03.GF8**.



**Aim Questions (Worksheet).** 🐛 Have the students answer the Aim Questions about today's Bible Adventure, **1TH03.GF9**.

- Passage Review Questions (Worksheet).** 🍌, 🦋 This booklet contains many questions from the Scripture passage covered in today's lesson. Students may work on them in class and complete them during the week at home, **1TH03.GF10**.
  - 1 Thessalonians 5:16-18 (Memory Verse Song).** 🍌 Words and music for today's memory verse are available upon request from Children's Ministry.
- 



### Took:

- Get Ready #3 (Activity).** 🍌, 🦋 Give each student a copy of **1TH03.GF11**. Have them write their names on it and tie it to one of the strings of a balloon cloud that was hung during the HOOK time. Take the balloon cloud outside to release it. Before releasing it, pray aloud for each of the students present to be ready for Christ's return.
- Encouraging Each Other With the Hope We Share (Activity).** 🍌, 🦋 1 Thessalonians 4:18 tells us to encourage each other with words of the hope of heaven. Give the students a copy of **1TH03.GF12** to color, cut, and paste onto a half piece of construction paper to make a card for a fellow believer. Have them give this to him or her this week and encourage them in the hope we share with them.
- Hope Soap on a Rope (Craft).** 🍌, 🦋 Have the students cut out the picture and verse on **1TH03.GF13** and glue it to a small bar of soap. Thread a piece of yarn through the hole in the soap and tie it in a knot. If they want to make it fancy, they can braid several different colors of yarn into one piece and thread that through the hole. This can be taken home and kept as a reminder of the hope we have in Christ, or given to an unbelieving friend or relative.
- "In the Twinkling of an Eye" (Object Lesson/Discussion).** 🍌, 🦋 Bring to class a bugle or trumpet (do not let the students know), and a suitcase that is packed for a journey, maybe to Disneyland, Grandma's house, camping, etc. You might have clothes, airline ticket, map, toothbrush, razor, hair dryer, make-up, food, shaving cream, deodorant, sleeping bag, Bible, etc. Be creative and think about what might be age-appropriate and important for the students in your class. As you pull each item out of the suitcase one at a time, ask the students about the importance of each item and what would be the most important to them if they were going on a trip. What would happen if they weren't ready for the trip on time? Ask them if they ever missed the school bus or a ride somewhere. Maybe they were late to a movie and weren't able to get in. What if they went camping and weren't fully prepared for rain? Have their parents ever told them to prepare for something, yet they didn't prepare? What kind of consequences did they face? In the Bible Adventure today they heard about Jesus' return to earth. While you are nearing the end of your discussion, have an assistant give a loud blast on the horn without any forewarning. Ask the students if they have given their lives to Christ. You never know when it will be too late. 1 Corinthians 15:51-52 says, "Listen, I tell you a mystery: We will not all sleep, but we will all be changed—in a flash, in the twinkling of an eye, at the last trumpet. For the trumpet will sound, the dead will be raised imperishable, and we will be changed."
- Funerals: How to Have Joy Even When We Are Sad (Discussion).** 🍌, 🦋 Discuss with the students how a funeral is a time to remember the life of someone they know and love. It is very sad because they and their families will miss the person who died. If a person dies and does not know Christ, a funeral is extremely sad. That person is in hell and separated from God. But if a person knows Christ, there is a sweet joy underneath the sadness. The joy comes in knowing that the person who died is in the presence of Jesus. They no longer suffer or are sad. Even better, if the person has trusted Christ, they will be reunited with him or her someday, either in heaven or at the rapture. Funerals are great times to challenge people with these truths. Encourage the students that, if someone there doesn't know Christ, they should tell him or her about Him. It is the only way to be united with Christ.



**Hope For the Hopeless (Activity).**  Bring in some newspaper clippings covering topics that might seem overwhelming or scary to those who have no hope. Explain that without Christ there is no hope. With Christ we have great eternal hope. No matter how bad things get here on earth, our home is in heaven. Spend some time in prayer thanking God for the hope we have, and for those still without hope.

# GET READY TO GO

In the suitcase below, pack all the things that you will need to be ready to go to the most exciting, wonderful place there is.

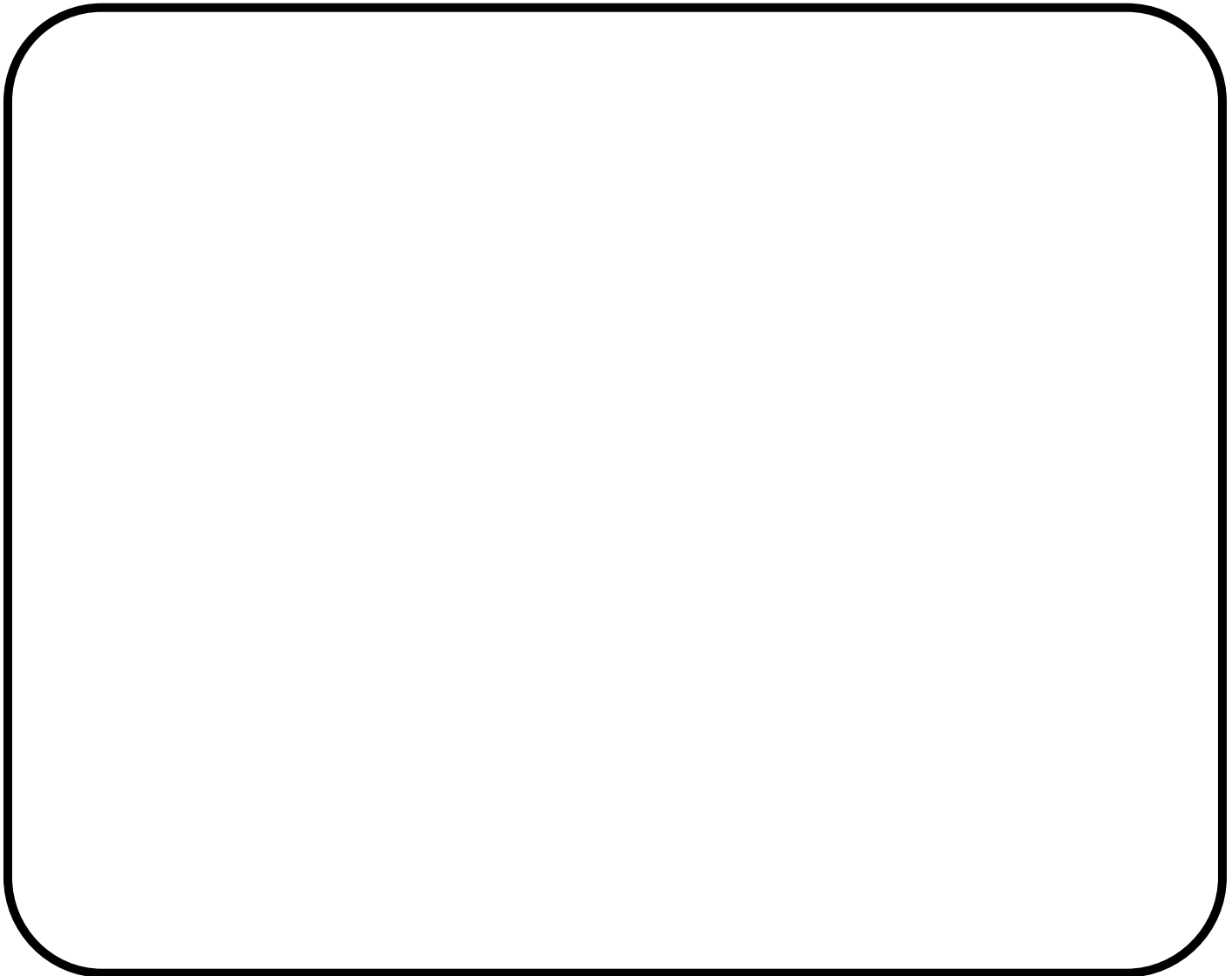

# Believers Meet Christ in the Air





# GET READY TO GO

In the suitcase below, pack all the things the Bible says you will need to be ready to go to heaven with Christ upon His return.

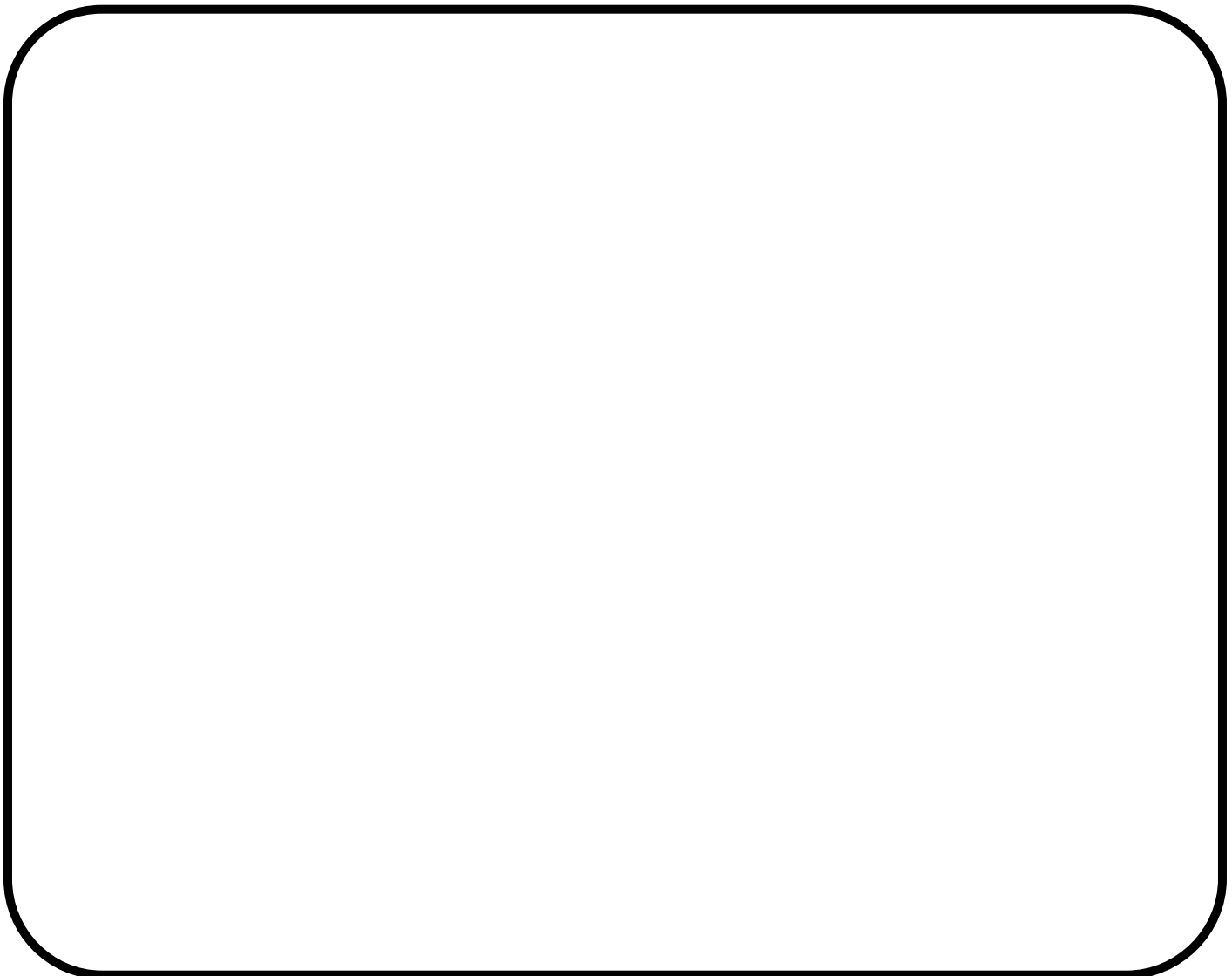

# The Rapture

"For the Lord Himself will come down from heaven with a loud command, with the voice of the archangel and with the trumpet call of God, and the dead in Christ will rise first. After that, we who are still alive and are left will be caught up together with them in the clouds to meet the Lord in the air. And so we will be with the Lord forever." 1 Thess. 4:16-17



How do we know that the rapture will happen?

"And if I go and prepare a place for you, I will \_\_\_\_\_ that you also may be where I am. You know the way to the place where I am going." **John 14:3**

What will the children of God be like after the rapture?

"Look at my hands and my feet. It is I myself! Touch me and see; \_\_\_\_\_, as you see I have." **Luke 24:39**

"Dear friends, now we are children of God, and what we will be has not yet been made known. But we know that when He appears, \_\_\_\_\_, for we shall see Him as He is." **1 John 3:2**

When is the rapture going to happen?

"No \_\_\_\_\_, not even the angels in heaven, nor the Son, but only the Father." **Matthew 24:36**

"Be \_\_\_\_\_! Be \_\_\_\_\_! You do not know when that time will come." **Mark 13: 33**

What will happen when Jesus returns?

"Do not be amazed at this, for a time is coming when all who are in their graves will hear his voice \_\_\_\_\_ those who have done good will \_\_\_\_\_ to live, and those who have done evil will \_\_\_\_\_ to be condemned." **John 5:28,29**

"And if the Spirit of Him who raised Jesus from the dead is living in you, He who raised Christ from the dead will also \_\_\_\_\_ your mortal bodies through his Spirit, Who lives in you." **Romans 8:11**

"We will not all sleep, but we will all be \_\_\_\_\_, in the \_\_\_\_\_ of an eye, at the last trumpet. For the trumpet will sound, the dead will be raised imperishable, and \_\_\_\_\_." **1 Cor. 15:51-52**

"But our citizenship is in heaven. And we eagerly await a Savior from there, the Lord Jesus Christ, Who, by the power that enables Him to bring everything under His control, will \_\_\_\_\_ our lowly bodies so that they will be like His glorious body." **Philippians 3:20,21**

J E S U S  
I S  
C O M I N G  
A G A I N !





Paste Tab Here

Paste Tab Here

“For the Lord Himself will come down from heaven, with a loud command, with the voice of the archangel and with the trumpet call of God, and the dead in Christ will rise first. After that, we who are still alive and are left will be caught up together with them in the clouds to meet the Lord in the air. And so we will be with the Lord forever.”

1 Thessalonians 4:16 -17

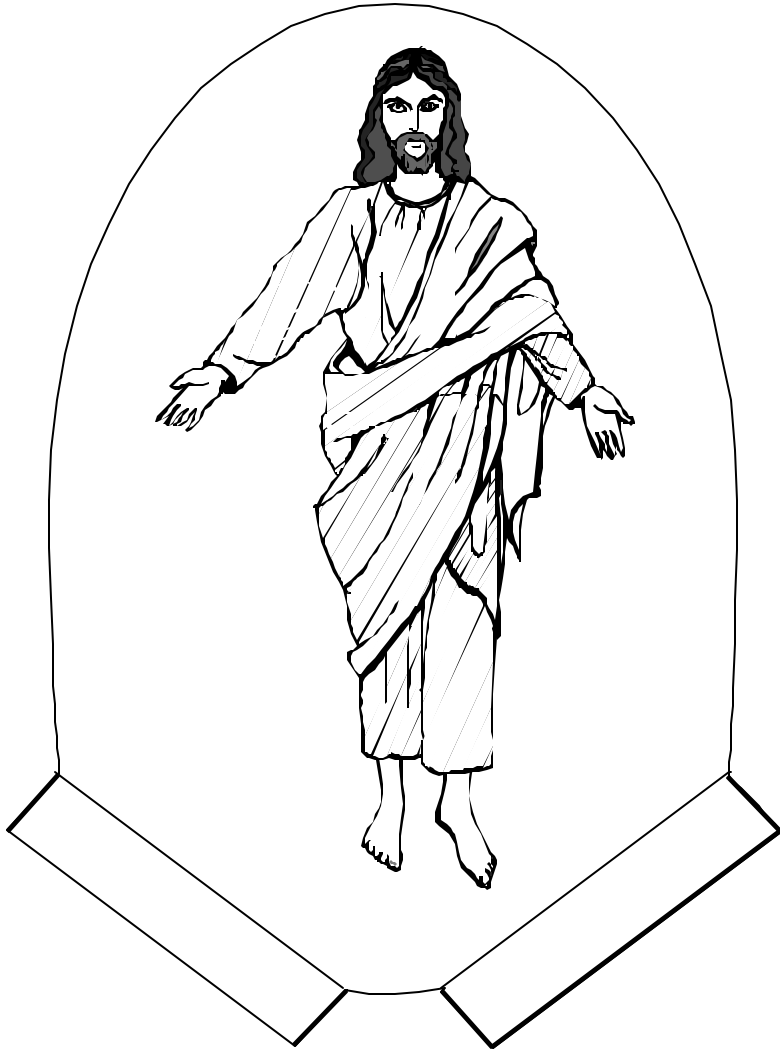

### INSTRUCTIONS

1. Print the cover and the cloud page on cardstock and the Jesus figure on white paper.
2. Carefully fold the cover and cloud page in half to form a booklet.
3. Carefully cut out the Jesus figure along the outside lines.
4. Fold the Jesus figure in half lengthwise with the figure on the outside to make a fold line. Then unfold and press the figure flat again.
5. Fold the tabs on the Jesus figure up to make tab fold lines. Then unfold and press flat.
6. Apply paste to the back of the tabs and attach the Jesus figure to the cloud page, making sure that the fold line of the figure aligns with the fold line of the cloud page.
7. Fold the booklet together and press flat.

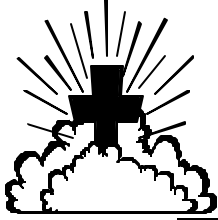

# VERSES of HOPE

Look up the following verses and fill in the missing words.



Psalm 39:7

“But now, \_\_\_\_\_, what do I look for? My \_\_\_\_\_ is in

Psalm 62:5

Find \_\_\_\_\_, O my soul, in \_\_\_\_\_ alone; my \_\_\_\_\_ comes

Romans 5:2b

\_\_\_\_\_ in the \_\_\_\_\_ of the \_\_\_\_\_ of God.

Romans 12:12

Be \_\_\_\_\_ in hope, patient in \_\_\_\_\_, faithful in \_\_\_\_\_.

Colossians 1:27

To them God has chosen to make known among the Gentiles the glorious riches of this \_\_\_\_\_, which is \_\_\_\_\_ in you, the \_\_\_\_\_ of \_\_\_\_\_.

1 Thessalonians 5:8

But since we belong to the \_\_\_\_\_, let us be \_\_\_\_\_, putting on \_\_\_\_\_ and \_\_\_\_\_ as a breastplate, and the \_\_\_\_\_ of \_\_\_\_\_ as a helmet.

Titus 3:7

so that, having been \_\_\_\_\_ by His \_\_\_\_\_, we might become heirs having the \_\_\_\_\_ of \_\_\_\_\_.

Hebrews 6:19

We have this \_\_\_\_\_ as an \_\_\_\_\_ for the \_\_\_\_\_, firm and \_\_\_\_\_.

Read 1 Peter 1:3-9 and tell each other what you think it means.

## GOD'S WILL FOR YOU

Find the memory verse by going down one column and up the next.  
Write the letters in the space below and then answer the question.

	<b>S</b>	<b>O</b>	<b>N</b>	<b>A</b>	<b>L</b>	<b>S</b>	<b>I</b>	<b>I</b>	<b>S</b>
	<b>T</b>	<b>C</b>	<b>T</b>	<b>N</b>	<b>L</b>	<b>I</b>	<b>S</b>	<b>R</b>	<b>T</b>
	<b>A</b>	<b>Y</b>	<b>I</b>	<b>I</b>	<b>C</b>	<b>H</b>	<b>G</b>	<b>H</b>	<b>J</b>
	<b>R</b>	<b>A</b>	<b>N</b>	<b>S</b>	<b>I</b>	<b>T</b>	<b>O</b>	<b>C</b>	<b>E</b>
	<b>T</b>	<b>R</b>	<b>U</b>	<b>K</b>	<b>R</b>	<b>R</b>	<b>D'</b>	<b>N</b>	<b>S</b>
		<b>O</b>	<b>P</b>	<b>A</b>	<b>N</b>	<b>C</b>	<b>O</b>	<b>S</b>	<b>I</b>
		<b>Y</b>	<b>S</b>	<b>L</b>	<b>A</b>	<b>U</b>	<b>F</b>	<b>W</b>	<b>U</b>
		<b>F</b>	<b>Y</b>	<b>L</b>	<b>H</b>	<b>M</b>	<b>S</b>	<b>I</b>	<b>O</b>
		<b>U</b>	<b>A</b>	<b>Y</b>	<b>T</b>	<b>S</b>	<b>E</b>	<b>L</b>	<b>Y</b>
		<b>L</b>	<b>W</b>	<b>G</b>	<b>E</b>	<b>T</b>	<b>C</b>	<b>L</b>	<b>R</b>
		<b>A</b>	<b>L</b>	<b>I</b>	<b>V</b>	<b>A</b>	<b>N</b>	<b>F</b>	<b>O</b>

Write the verse here.

What is God's will for you

- 1.
- 2.
- 3.

# Aim Questions

Answer the following questions about today's Bible Adventure.

1. What did Paul want the Thessalonians to do concerning their daily Christian life?
2. In what part of holiness did Paul especially want them to grow in?
3. What is the great hope of the Christian?
4. How is that a comfort when thinking about friends and family who have died as Christians?
5. Why do Christians need to grow in their love?
6. How can you live like there is hope for the future?

*Is your heart's desire to grow to be more like Christ?*

*Is your hope the great hope of being united with Christ together with other believers for eternity?*

*This week, pray that God will show you any areas in your life that are getting in the way of desiring Him more than anything else.*

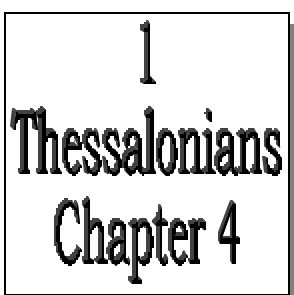

1 Thessalonians 5:16-18

“Be joyful always; pray continually; give thanks in all circumstances, for this is God’s will for you in Christ

## **Passage Review Questions**

### **1 Thessalonians 4**

What instruction did Paul give to the Thessalonian church? (4:1)

Through whose authority did they give commandments to the church? (4:2)

From what things were the Thessalonians to stay away? (4:3-8)

If someone rejected what Paul and his companions were saying, who were they really rejecting? (4:8)

What did Paul urge them to continue practicing and to practice it even more? (4:9-10)

What were some other character qualities that Paul wanted the Thessalonians

to grow in? (4:11)

Why did Paul want the Thessalonians to grow in these areas? (4:12)

What does Paul mean when he talks about the 'brothers who are asleep'? (4:13)

Do those who die without Christ have any hope in living with God forever? (4:13)

Did Paul believe that Jesus died and rose again? (4:14)

Who will Jesus take to heaven first, the dead or the living? (4:14-15)

Describe Christ's return for the believers. (4:16)

When Christ calls the believers up, where will we meet Him? (4:17)

Once we meet the Lord in the air, will we always be with Him? (4:18)

What does Paul say to do with the words that he had just spoken to the Thessalonians? (4:18)

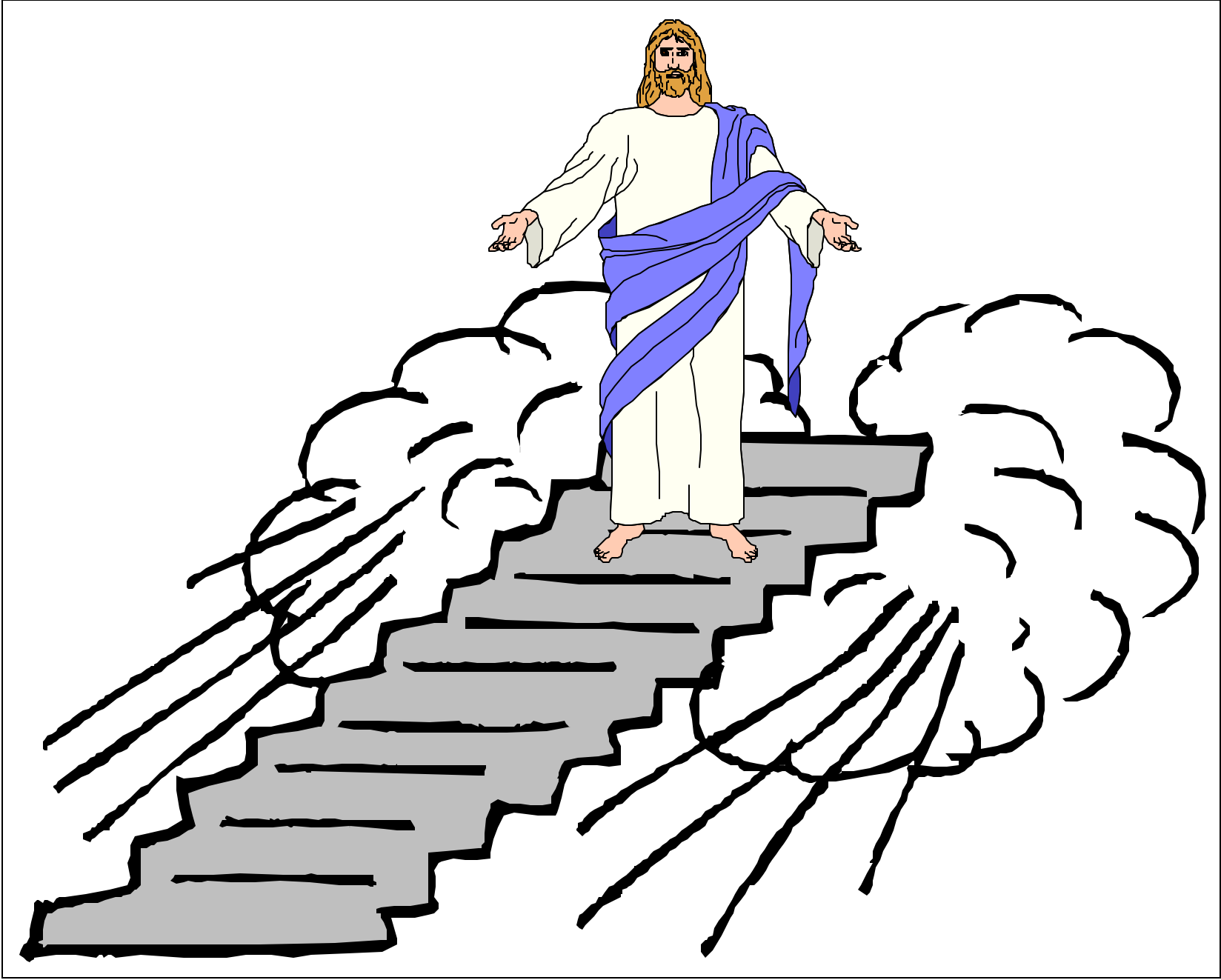

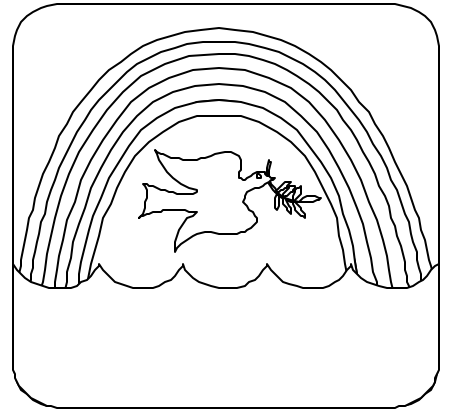
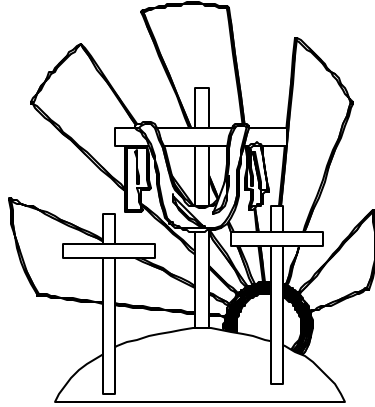
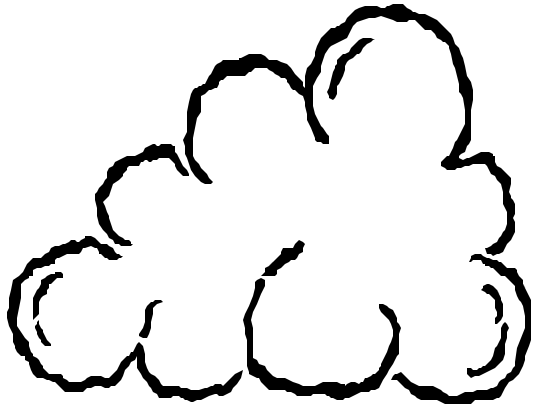
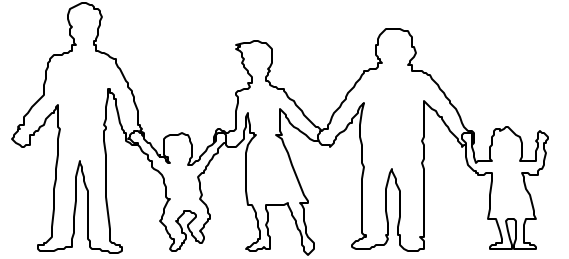
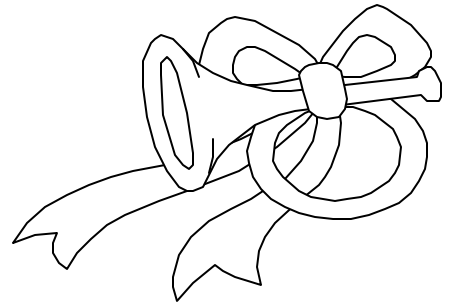
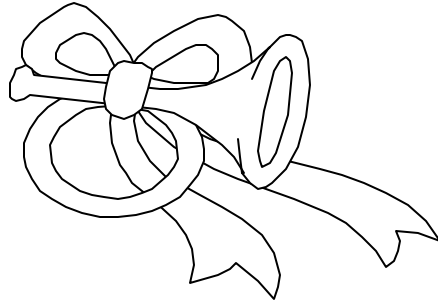
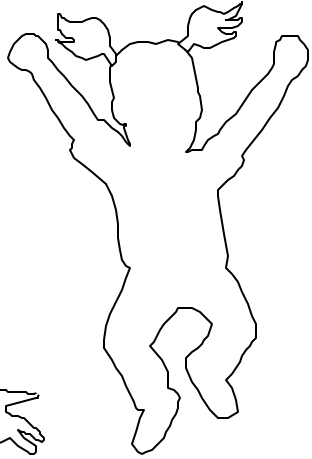
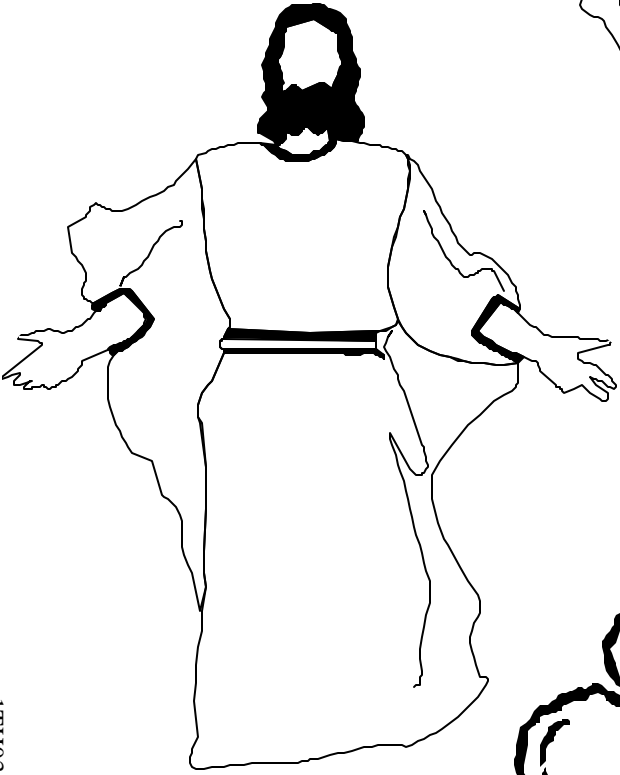
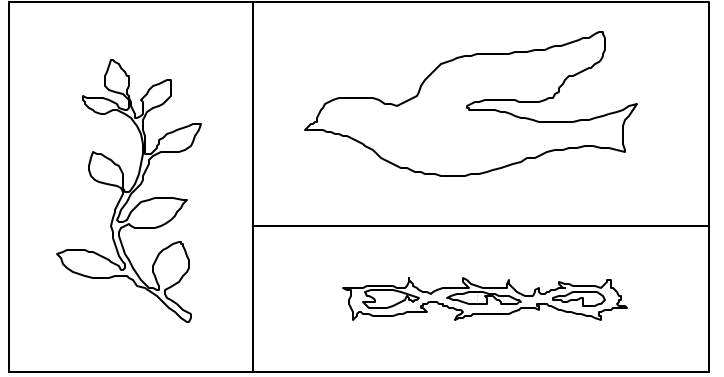
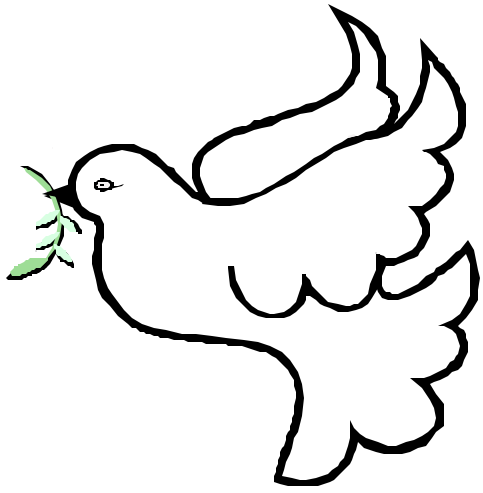
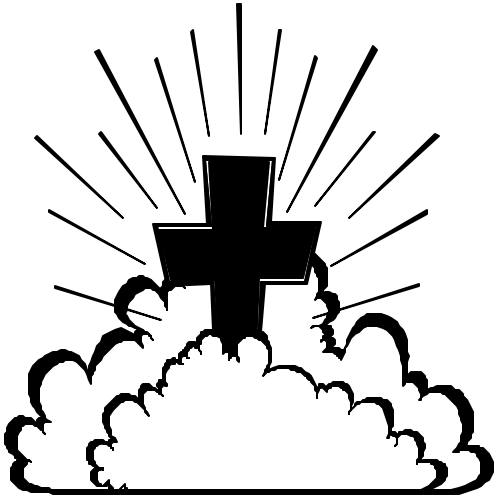

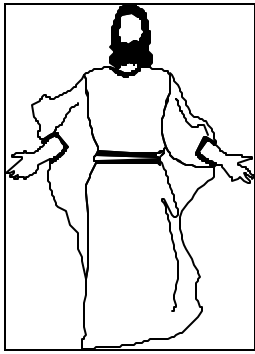

Christ  
will return  
and we will be  
with Him.  
1 Thessalonians  
4:13-18



Christ  
will return  
and we will be  
with Him.  
1 Thessalonians  
4:13-18

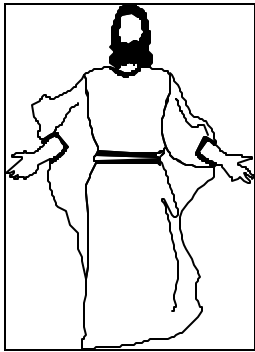

Christ  
will return  
and we will be  
with Him.  
1 Thessalonians  
4:13-18



Christ  
will return  
and we will be  
with Him.  
1 Thessalonians  
4:13-18

Christ  
will return  
and we will be  
with Him.  
1 Thessalonians  
4:13-18

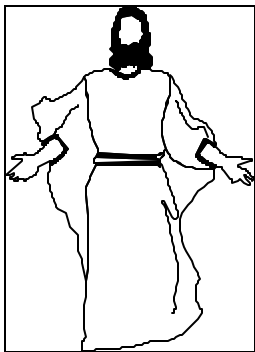

Christ  
will return  
and we will be  
with Him.  
1 Thessalonians  
4:13-18



Christ  
will return  
and we will be  
with Him.  
1 Thessalonians  
4:13-18

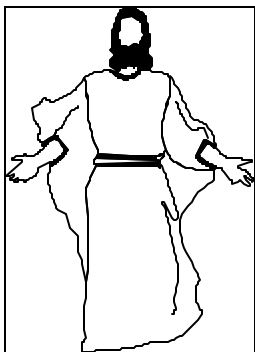
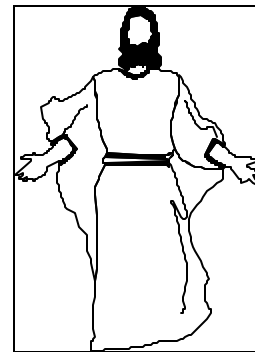

Christ  
will return  
and we will be  
with Him.  
1 Thessalonians  
4:13-18



Christ  
will return  
and we will be  
with Him.  
1 Thessalonians  
4:13-18

Christ  
will return  
and we will be  
with Him.  
1 Thessalonians  
4:13-18

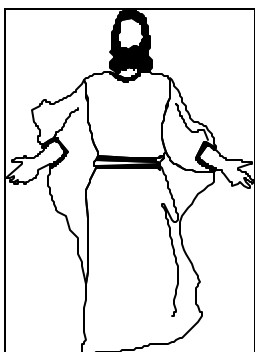

Christ  
will return  
and we will be  
with Him.  
1 Thessalonians  
4:13-18



Christ  
will return  
and we will be  
with Him.  
1 Thessalonians  
4:13-18

# Hope Soap on a Rope